



ULTRA FIJN STOF EN FIJN STOF EN KLIMAAT VERANDERING

Challenge the future

Botanische Tuin TU Delft, Afdeling Biotechnologie,
Faculteit Technische Natuurwetenschappen

**TU**Delft

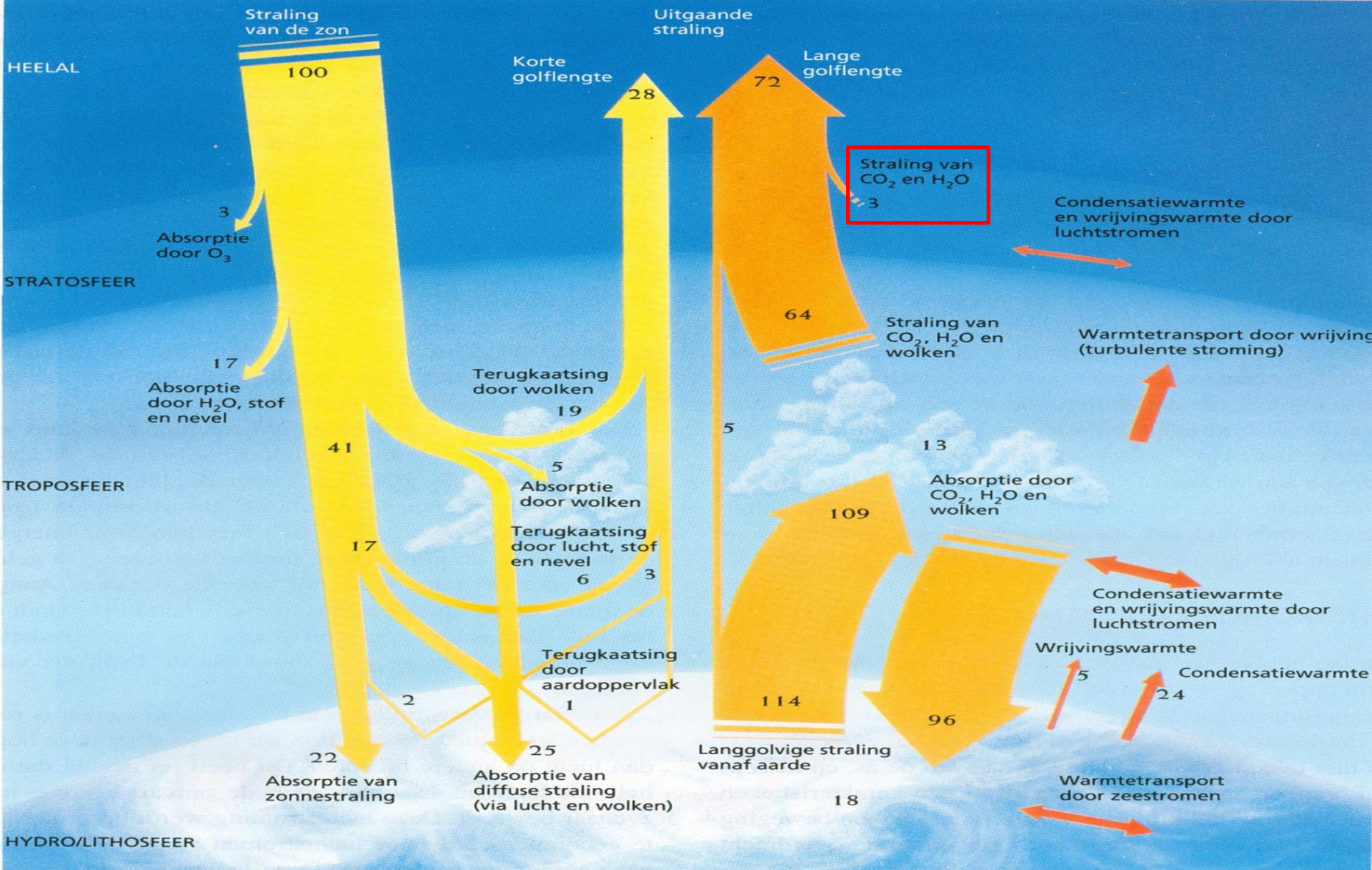

Challenge the future

Atmospheric Absorption Bands

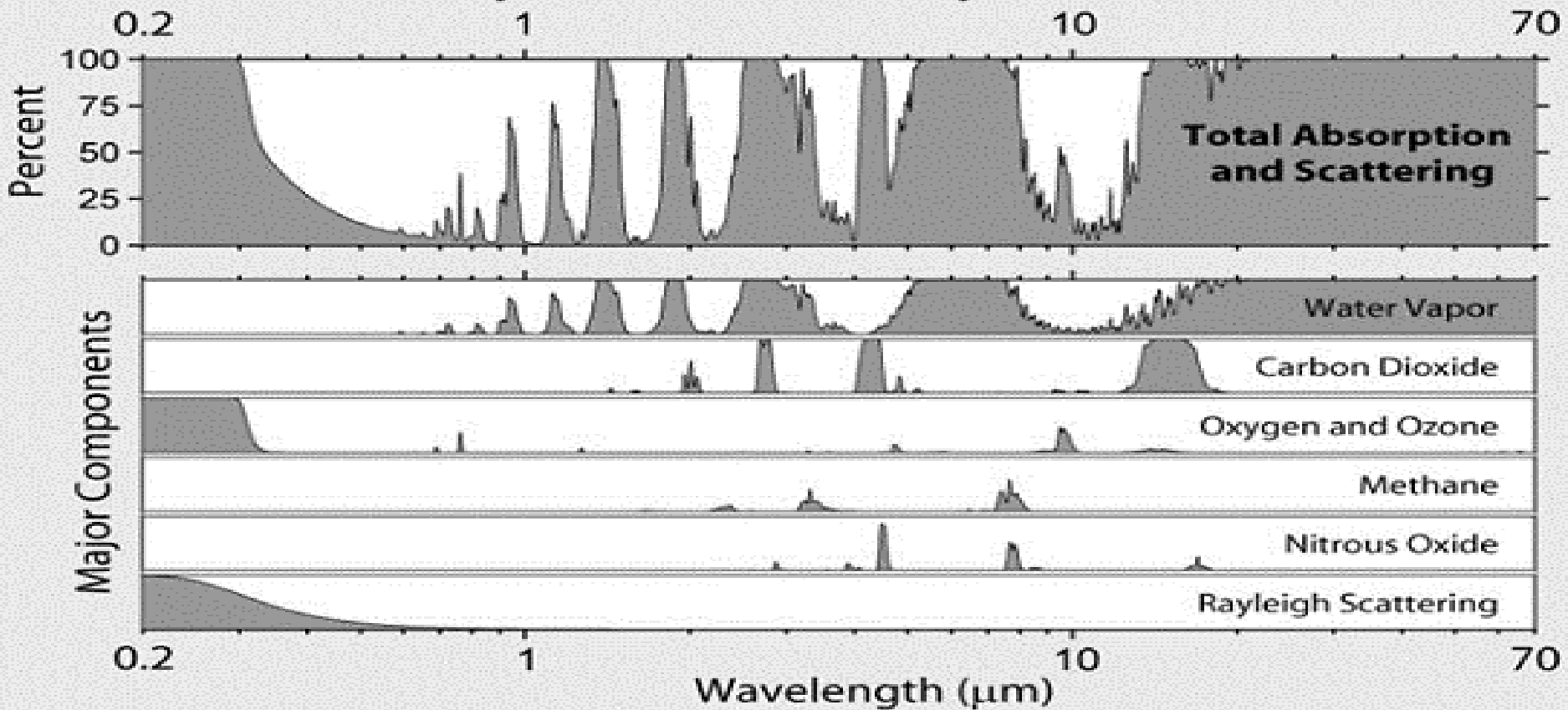

CO₂ gehalte bedraagt 5% en 95% water als damp en druppels van de atmosfeer. Numeriek is de impact van koolstofdioxide gering ten opzichte van water. Een gas of een damp bezitten geen massa en daardoor geen vermogen tot warmtecapaciteit en gereguleert in Albedo patronen met een globale totaal impact van 0,3 ° Celsius en binnen de bandbreedte van de homeostatische onnauwkeurigheid in de totale stralingbalans. Bron: Robert A. Rhode/Global Warming Art, Berkeley, 2011

Challenge the future

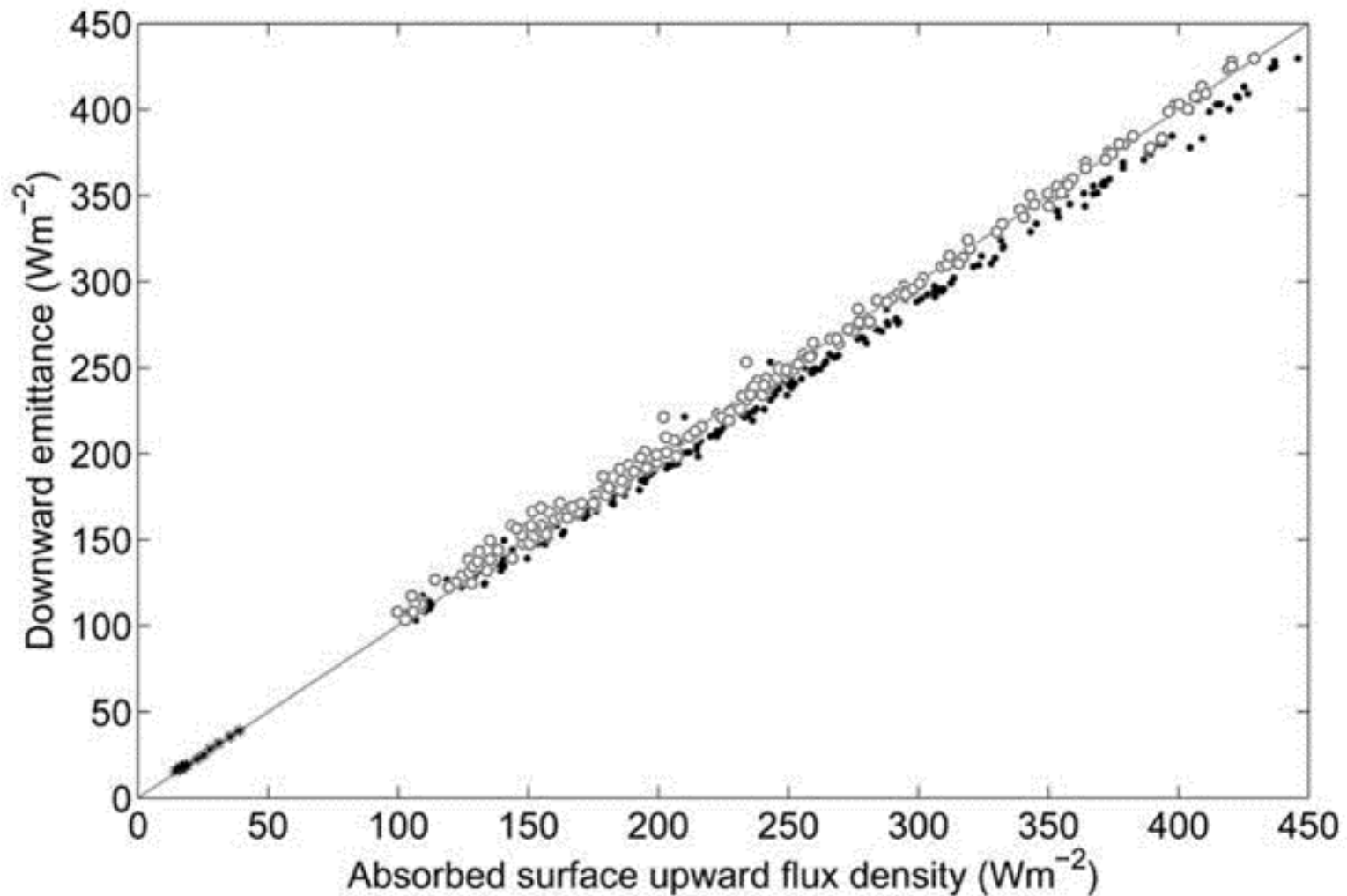

228 selected radiosondes tonen op de verticale as de neergaande lang golvige straling van de zon en op de horizontale as de opwaardse lang golvige radiatie. De aarde warmt niet op in een holistische benadering zoals te zien is sinds satalliet data. *Miskolszi, 2008*

Challenge the future

Projections of Surface Temperature Changes

(relative to 1980–99 and based on a midrange emissions scenario)

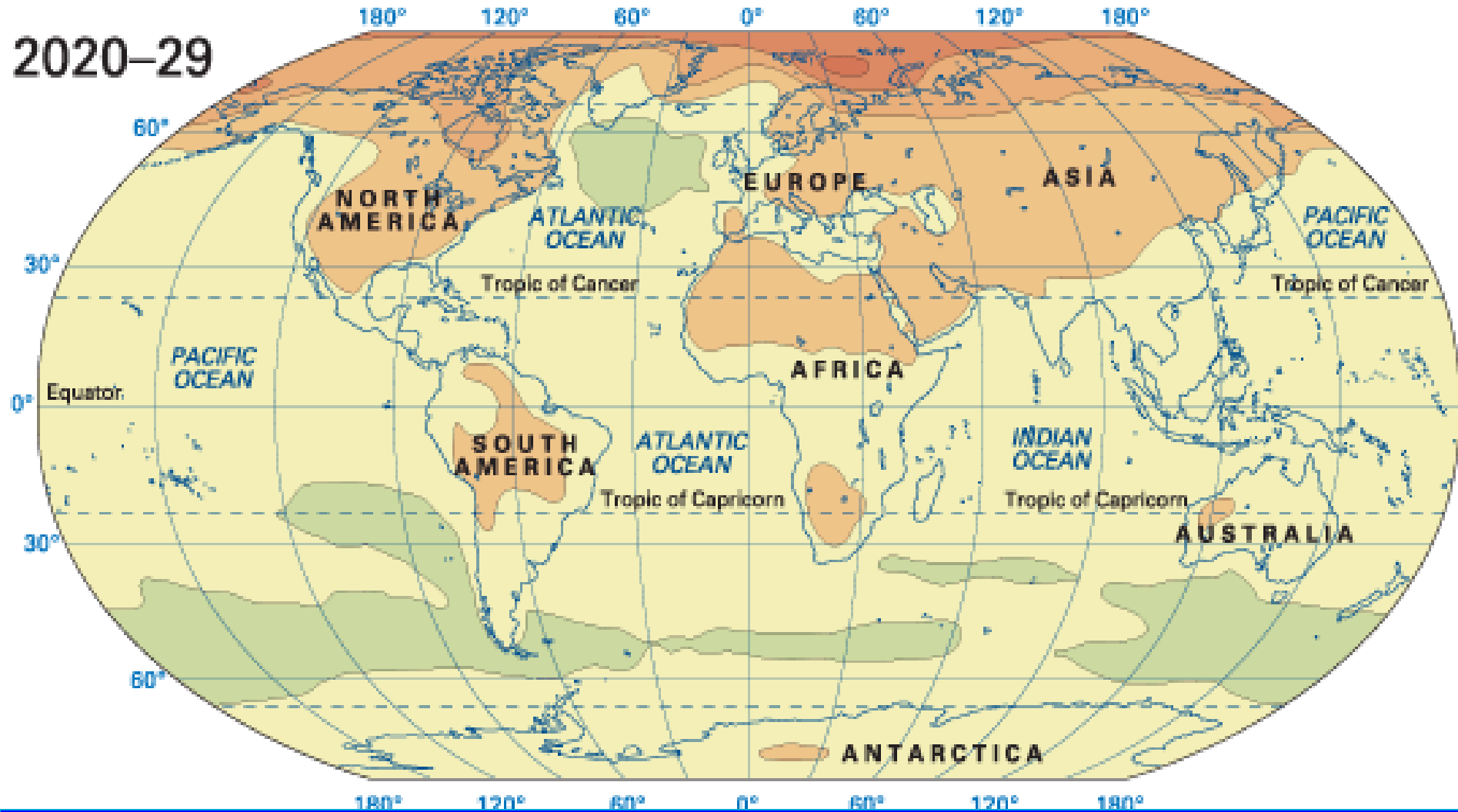

Challenge the future

Projections of Surface Temperature Changes

(relative to 1980–99 and based on a midrange emissions scenario)

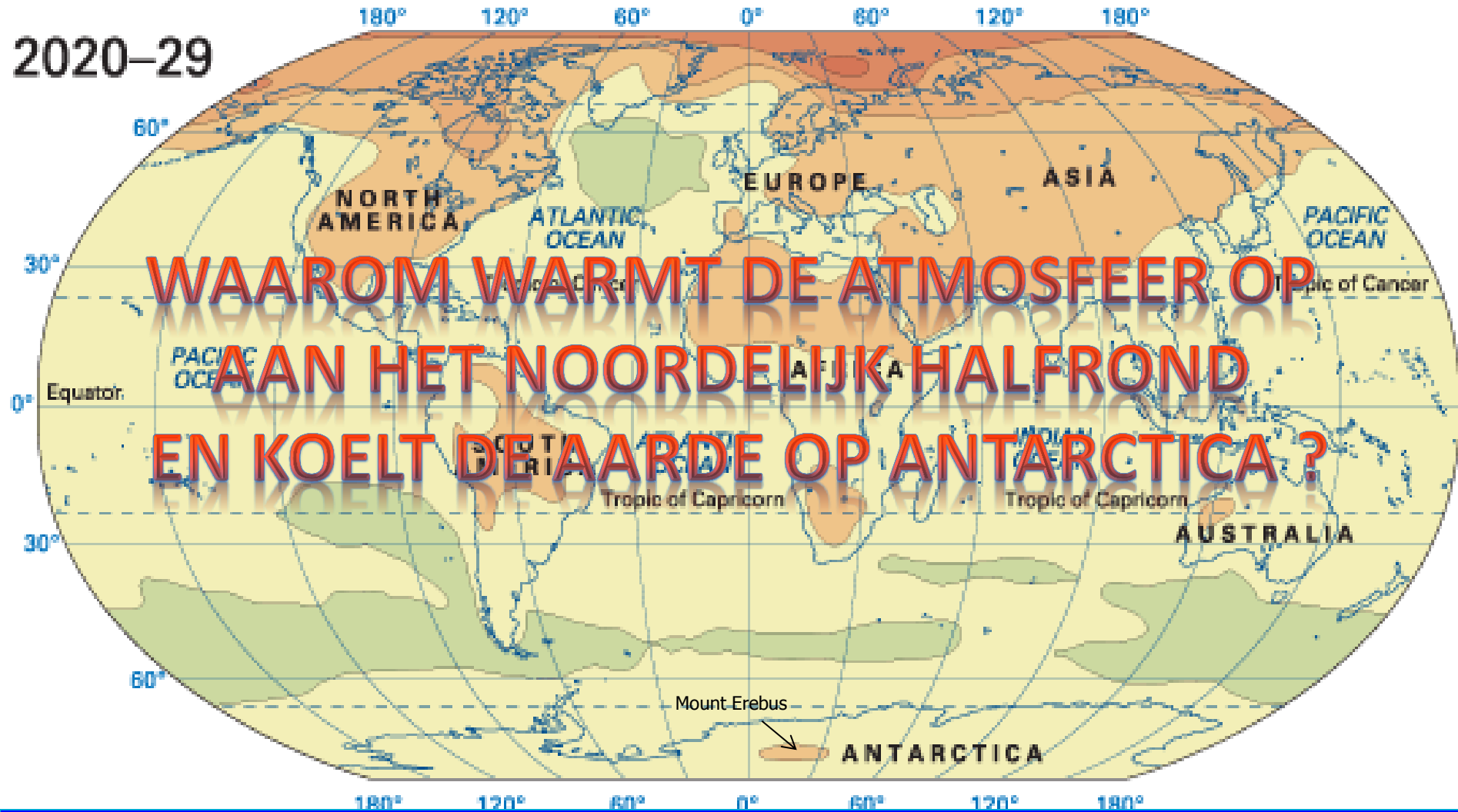

Challenge the future

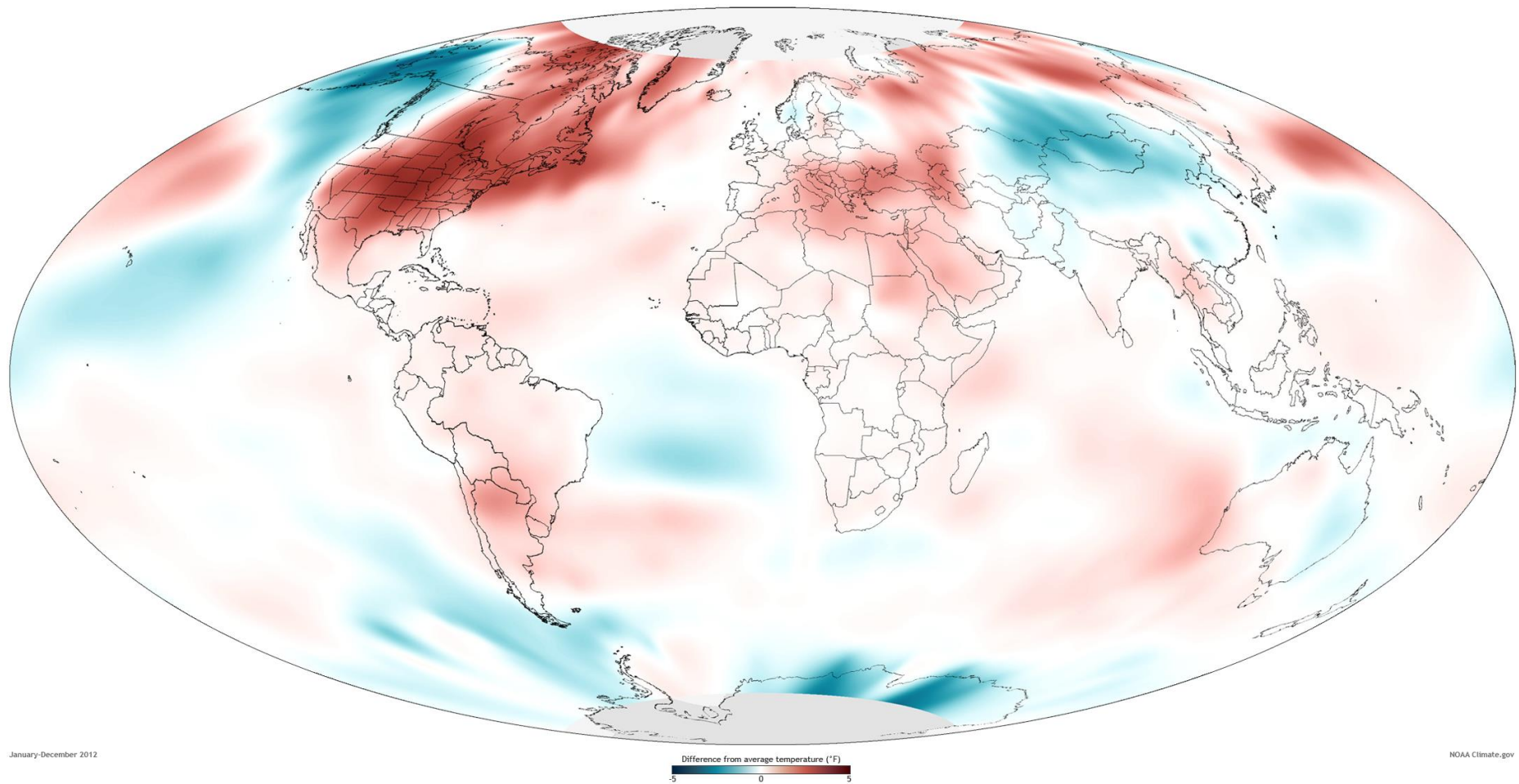

Oppervlakte temperatuur in 2012 vergeleken met waarden van 1981 tot 2010 gemiddelden en gebaseerd op samengevoegde temperatuur meet data van land en oceanen.

NOAA map, Dan Pisut, NOAA environmental visualization laboratory, National Climate Data Centre 2012.

Challenge the future

Botanische Tuin TU Delft, Afdeling Biotechnologie,
Faculteit Technische Natuurwetenschappen

TU Delft

Hoe wordt de opwarming op het noordelijk halfrond veroorzaakt?

Stel het is een gas, zoals CO₂:

- Een gas of damp heeft bijna geen massa
- Een gas of damp heeft daardoor beperkt of geen warmte vasthoudend vermogen, nihil effect op warmtecapaciteit
- Een gas of damp heeft de eigenschap om zich homogeen over een ruimte te verspreiden en zal altijd de ruimte volledig vullen
- Een gas of damp houdt maar zeer gering straling tegen.
- Een gas, zoals CO₂ in het bijzonder, is numeriek slechts 5% van de totale atmosfeer en gering van impact ten opzichte van water (betekenis als vloeistof)

Stel het is een vloeistof, zoals water:

- Water heeft een massa en een grote warmte capaciteit
- Water stroomt via oceanen en door zeestromingen verdeeld over de aarde en draagt eerder bij als regulerend koelmechanisme (afkoelend op Artica en Antarctica)
- Water zet straling om in warmte
- Water is voor 95% het grootste bestanddeel van de atmosfeer

Stel het is een vaste stof, zoals fijn stof en ultra fijn stof:

- Stof heeft een massa en dus warmtecapaciteit
- Stof verdeeld zich niet homogeen moet door wind verplaatst worden
- Stof houdt straling tegen en warmt op
- Stof komt niet hoger dan de inversielaag, tenzij het bestaat ultra fijn stof dat niet massa en reageert zwaartekracht gedreven en elektrisch geladen gedreven, accumuleert op de elektrofeer (50 km hoogte)

Challenge the future

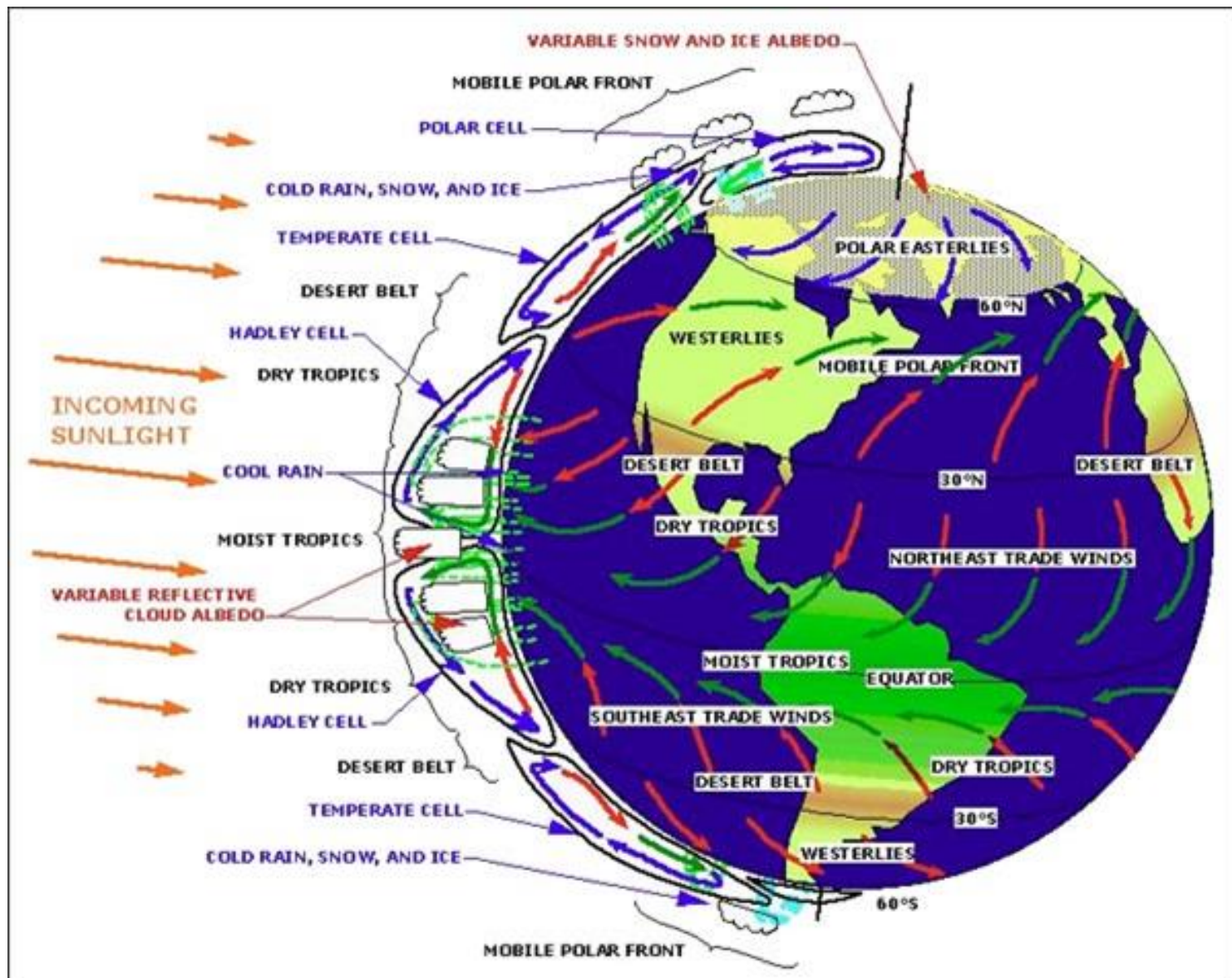

Challenge the future

FUKUSHIMA Potential Releases:

Xe-133, Total Column

Analysis: 2011-04-20 03:00:00, Date: 2011-04-20 06:00:00 UTC

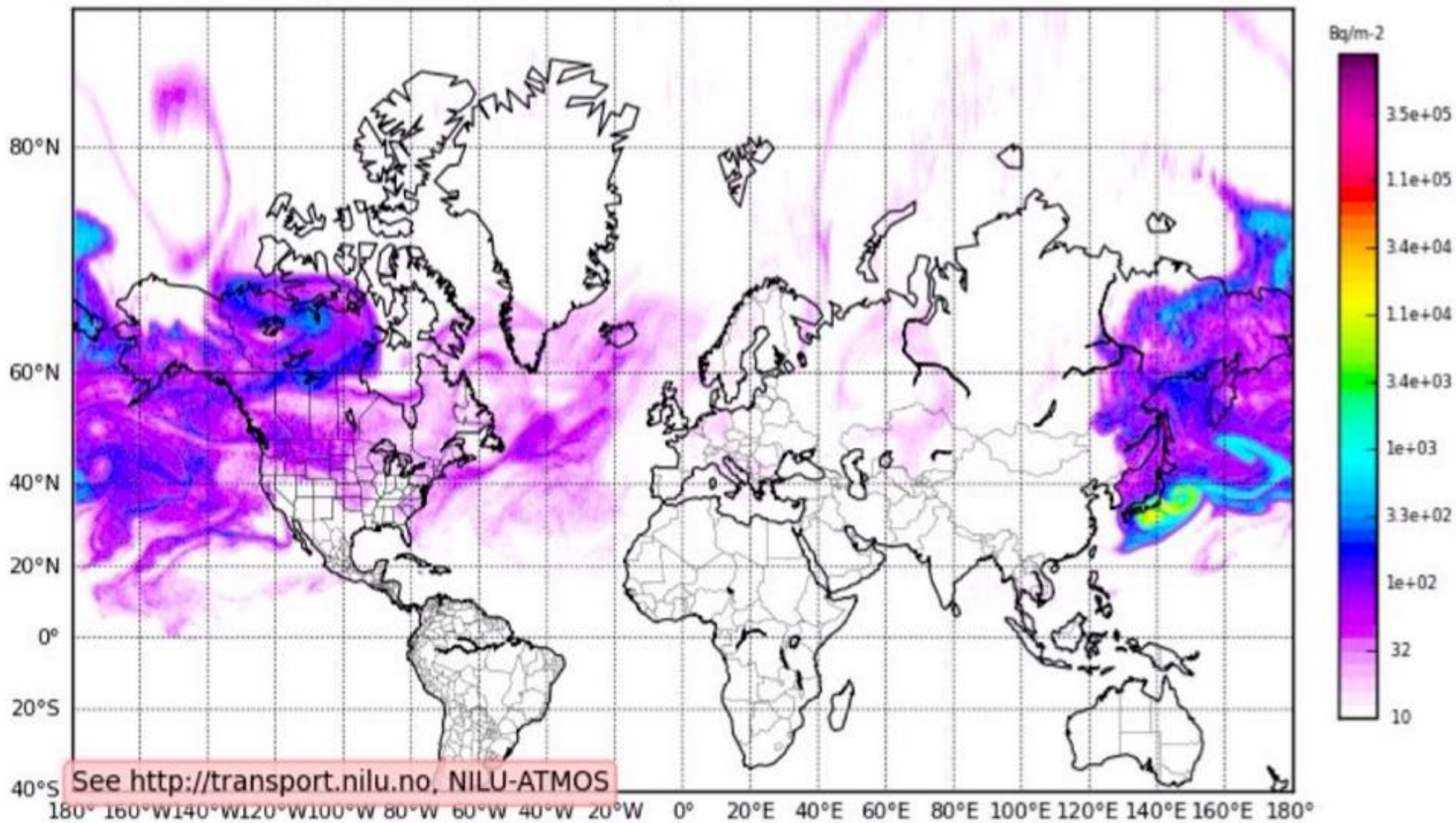

Challenge the future

Botanische Tuin TU Delft, Afdeling Biotechnologie,
Faculteit Technische Natuurwetenschappen



Verdeling van de Wereldbevolking over de verschillende continenten

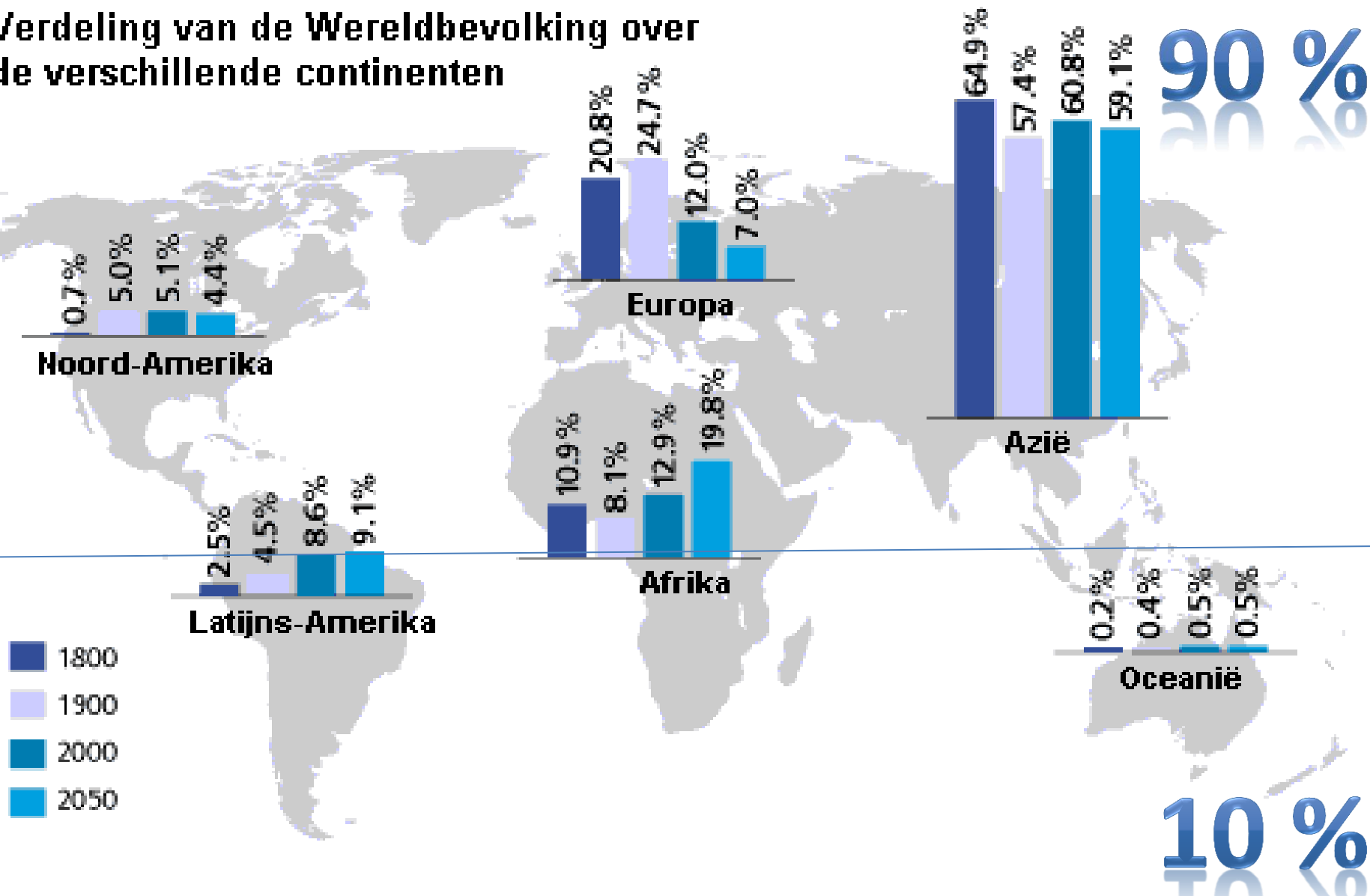

Challenge the future



NATUURLIJKE FEED BACK SYSTEMEN

Challenge the future

Botanische Tuin TU Delft, Afdeling Biotechnologie,
Faculteit Technische Natuurwetenschappen

**TU**Delft



Challenge the future

Botanische Tuin TU Delft, Afdeling Biotechnologie,
Faculteit Technische Natuurwetenschappen



Thermohaline Circulation

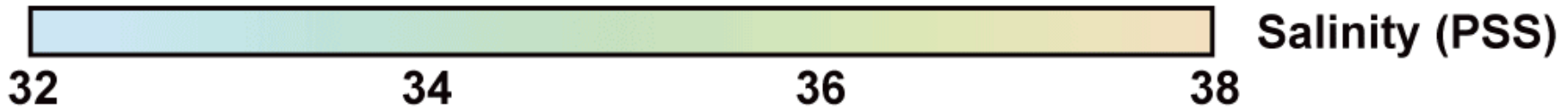
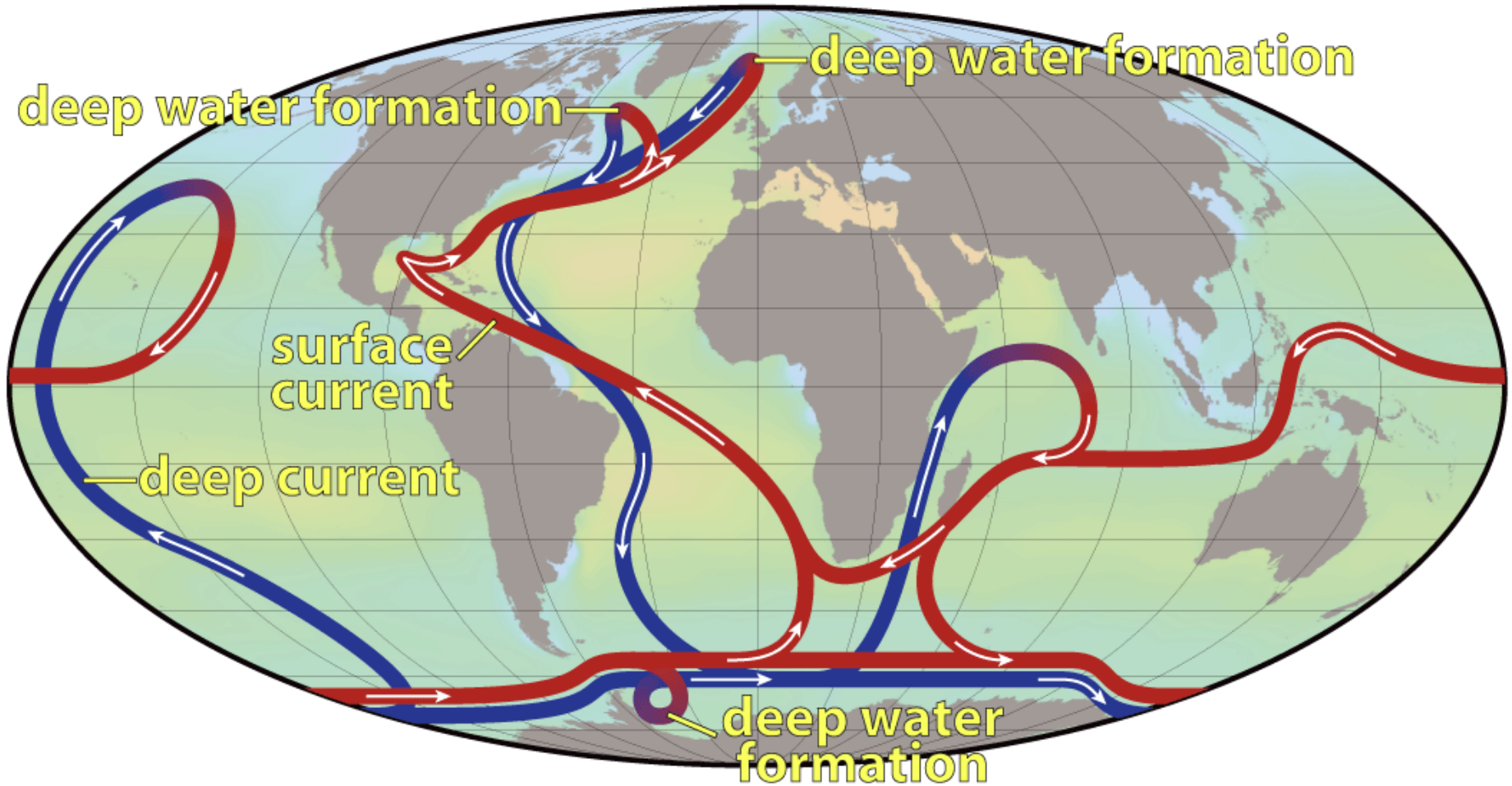

Robert Simmon, minor modifications by Robert A. Rhode, NASA Earth Observatory **Challenge the future**

Botanische Tuin TU Delft, Afdeling Biotechnologie,
Faculteit Technische Natuurwetenschappen



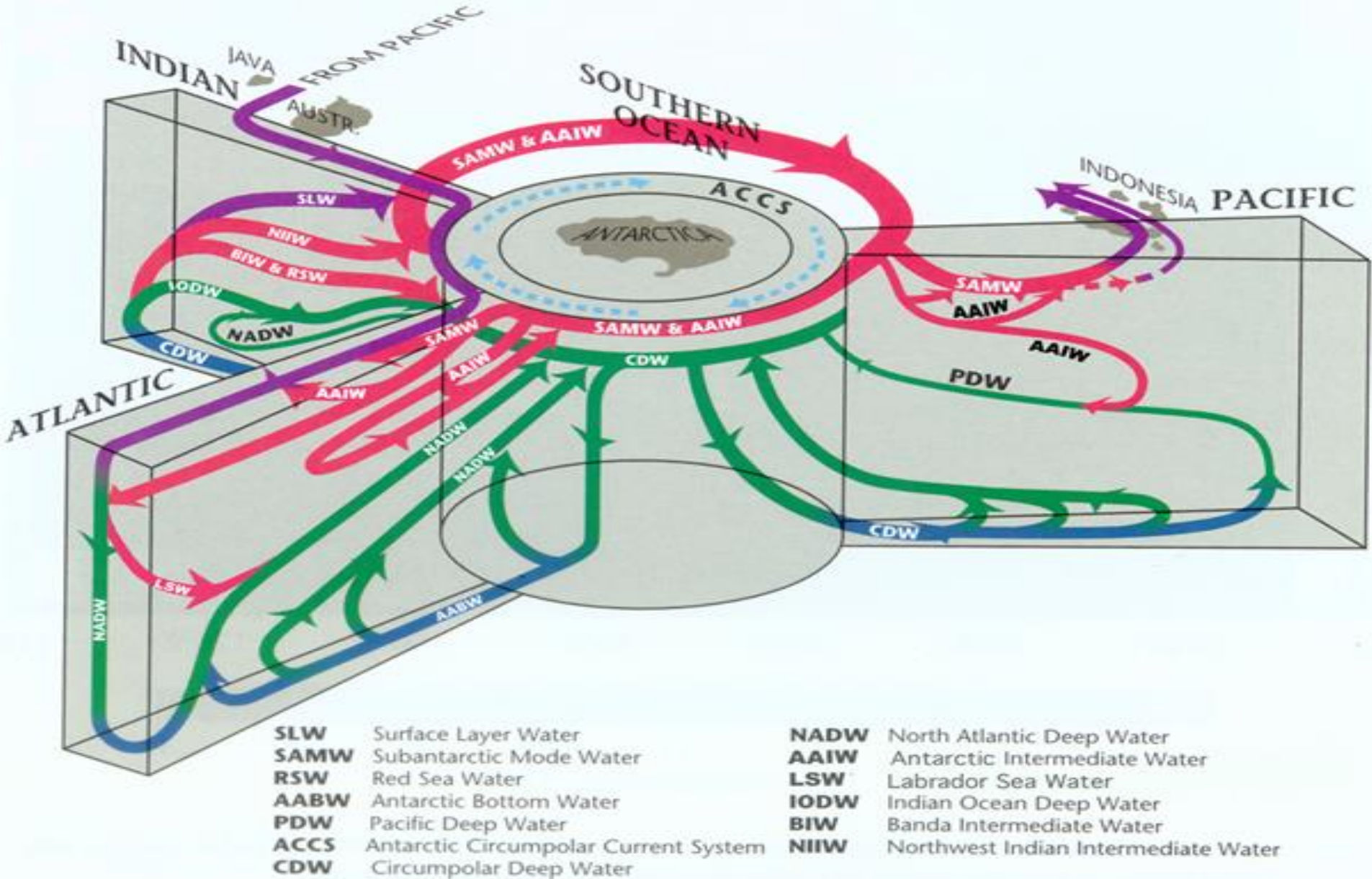

Challenge the future

Southern Hemisphere Sea Ice Anomaly

Anomaly from 1979-2008 mean

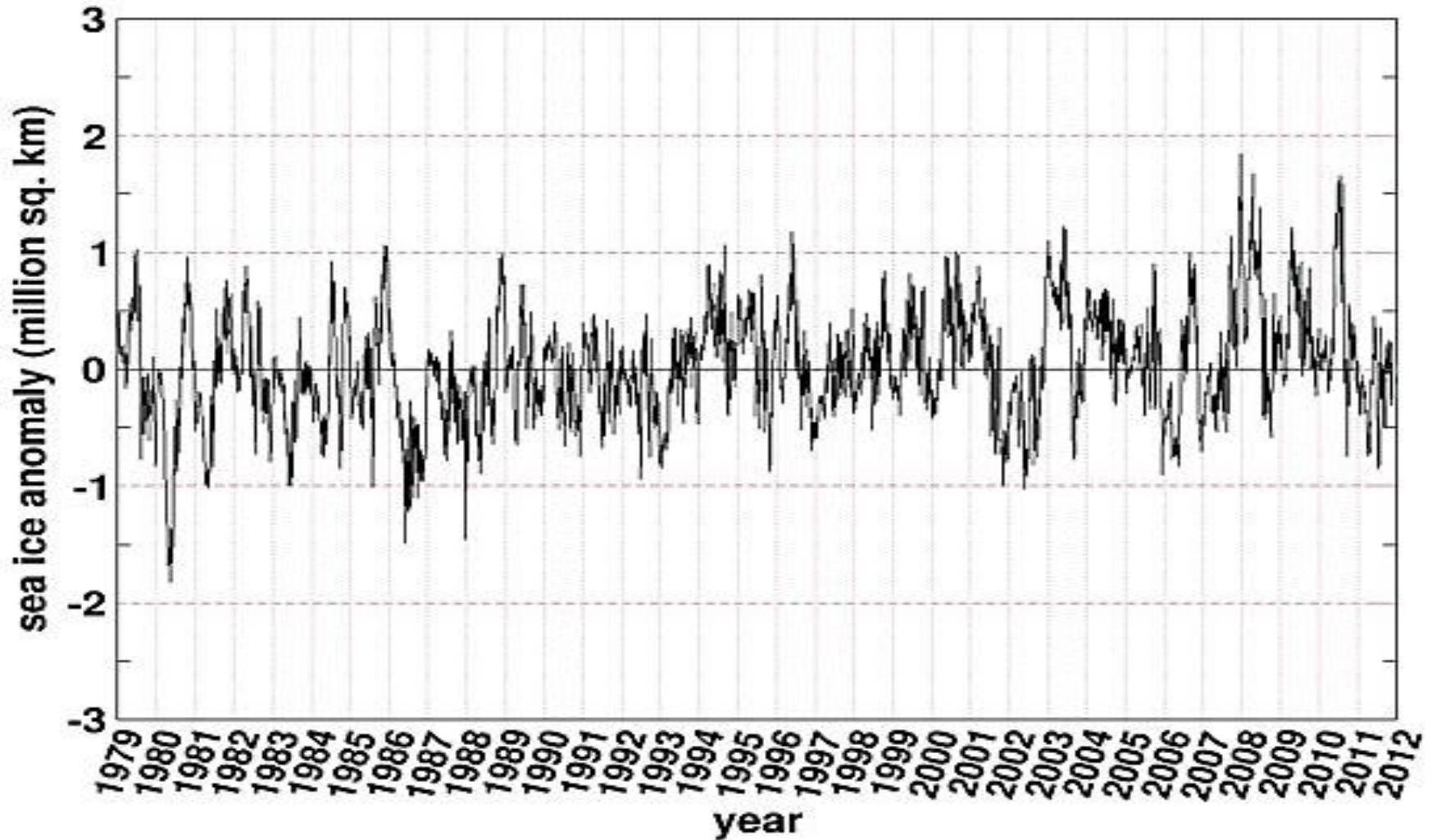

Challenge the future

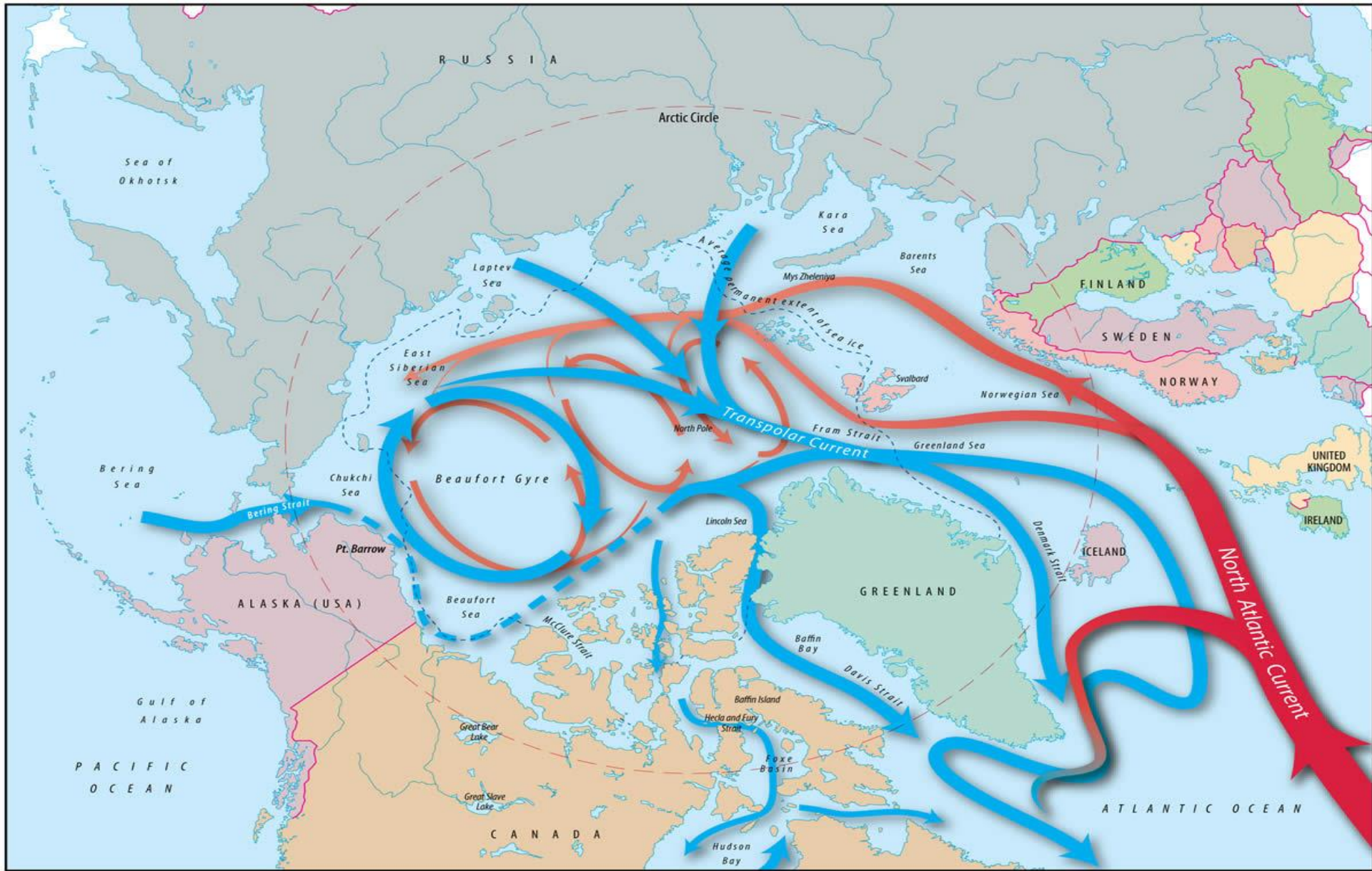

Challenge the future

Botanische Tuin TU Delft, Afdeling Biotechnologie,
 Faculteit Technische Natuurwetenschappen



Northern Hemisphere Sea Ice Anomaly

Anomaly from 1979-2008 mean

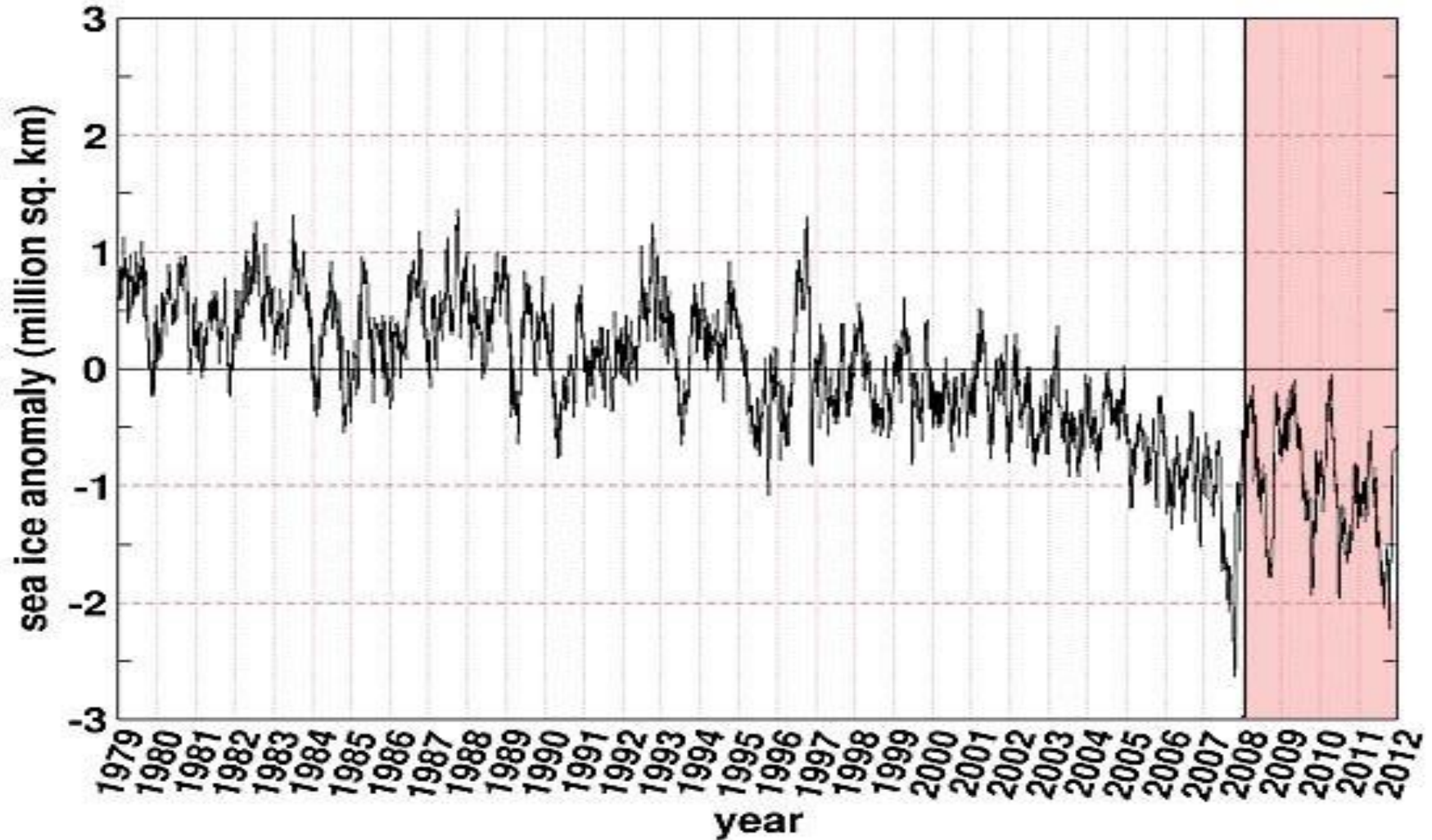

Challenge the future

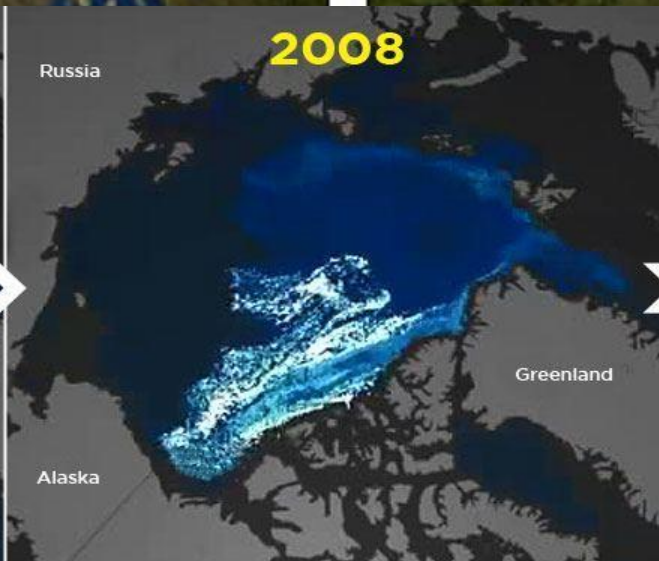
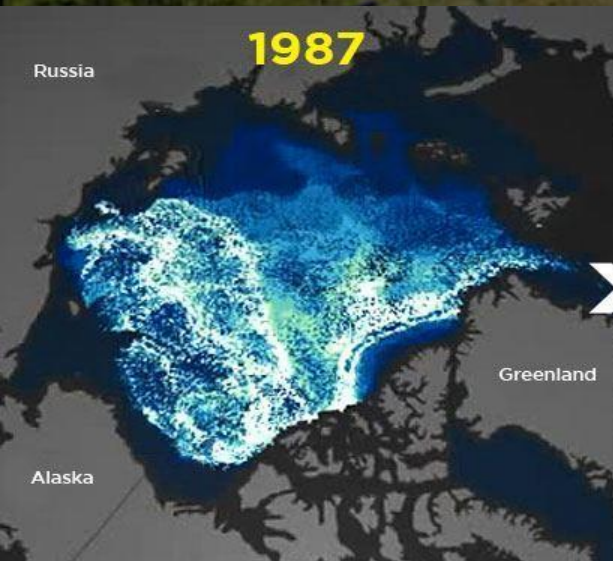

Challenge the future

Botanische Tuin TU Delft, Afdeling Biotechnologie,
Faculteit Technische Natuurwetenschappen

**TU Delft**

Klimaat regulatie via planten (LAI en LAR) en vegetatie structuur toename in Boreale en Arctische regio's.

Leaf Area Index – May

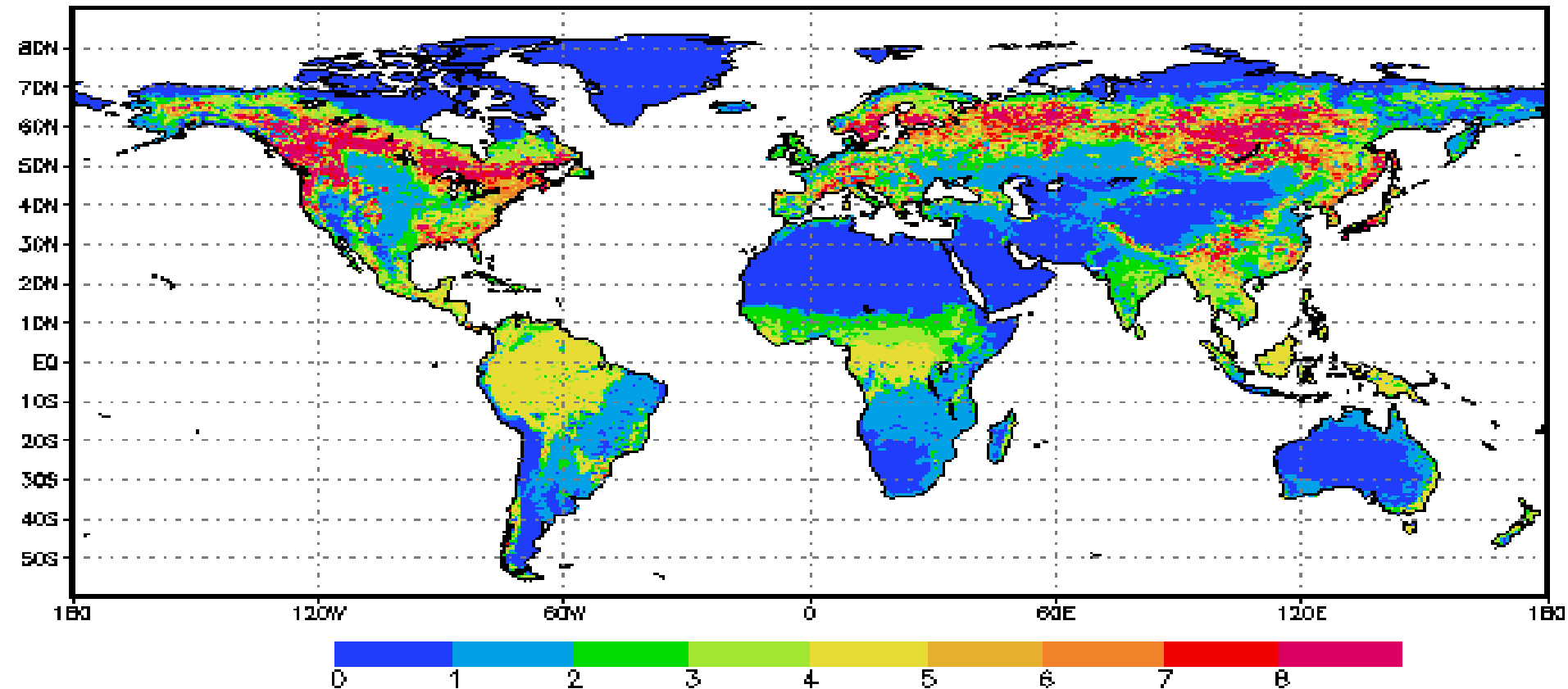

Challenge the future

Botanische Tuin TU Delft, Afdeling Biotechnologie,
Faculteit Technische Natuurwetenschappen

 TU Delft

AMMONIAK AFVANGST IN DE LANDBOUW & KANSEN VOOR DE INDUSTRIE

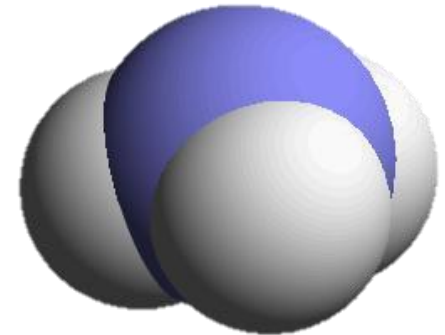
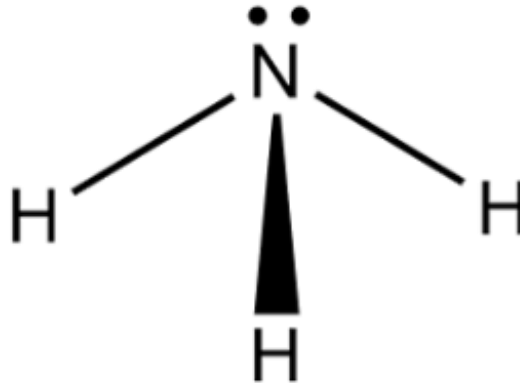
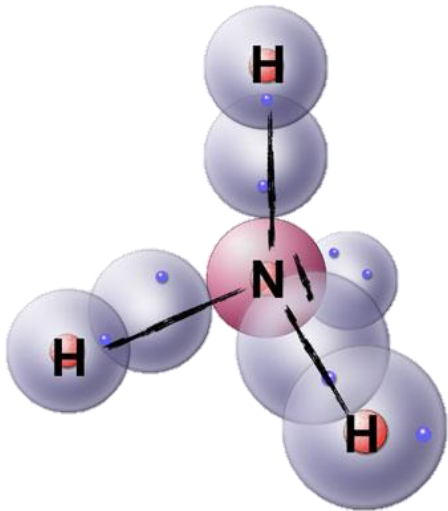

Challenge the future

Waarom is reductie van ammoniak nodig?

Nadelige effecten op mens en dier:

- Nadelige invloed op de vruchtbaarheid
- via borstvoeding op de gezondheid van babies
- Aantasting van de huid
- Aantasting van de longen
- Aantasting van de ogen

Nadelige effecten op de natuur:

- Ammoniak geeft bodemverzuring en vermisting
- Dus verlies van biodiversiteit , met name korstmossen

Hinder: STANK

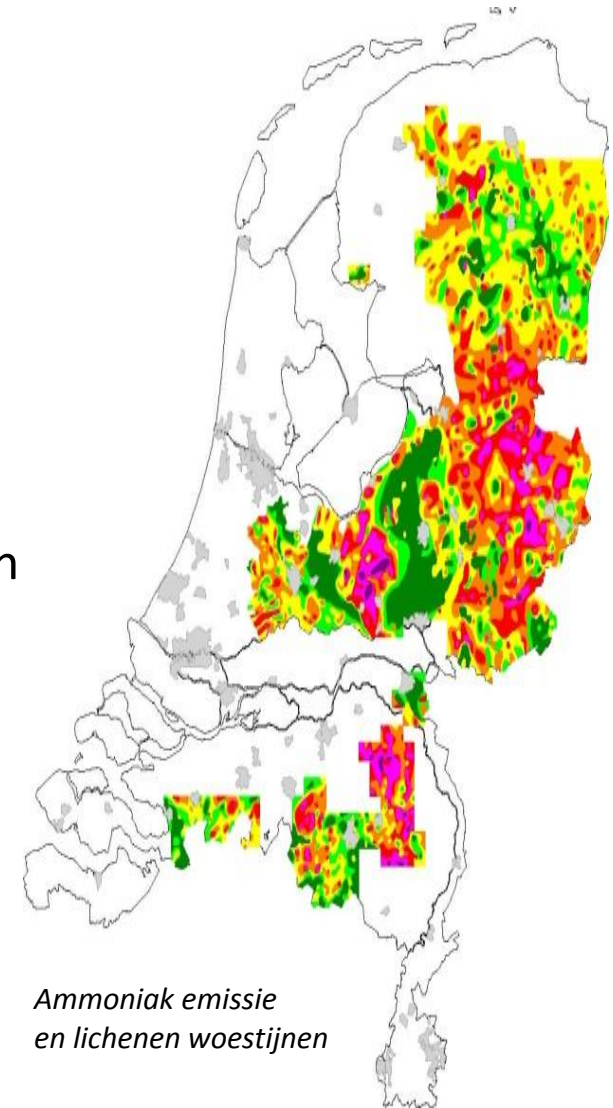

Challenge the future

Waarom is reductie van ammoniak nodig?

Emissie ammoniak (NH₃)

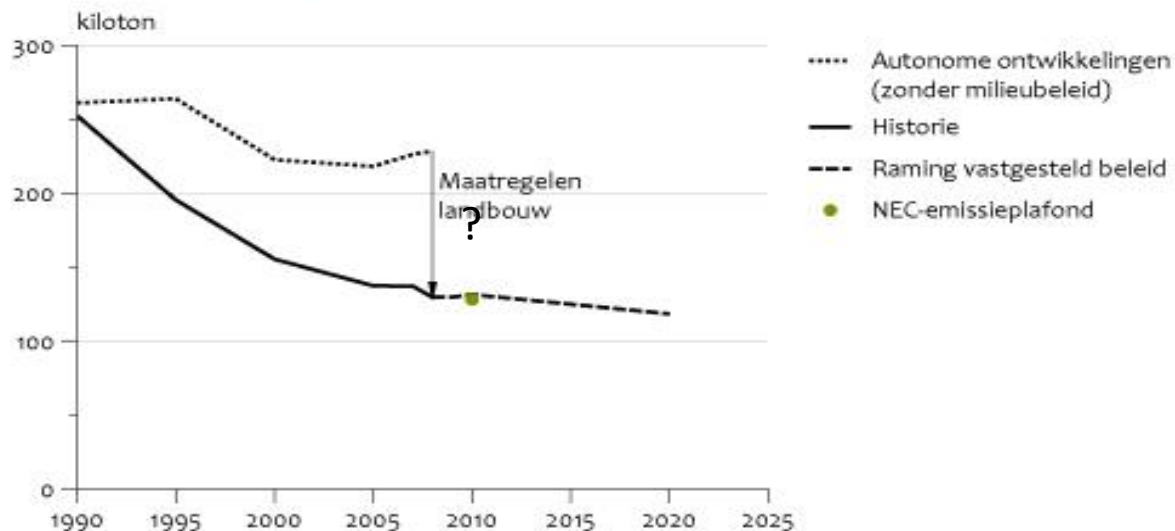

Bron: Emissieregistratie, ECN en PBL.

www.planbureauvoordeleefomgeving.nl

De nationale emissie van ammoniak (NH₃) heeft een plafond van 128 kiloton per jaar. In 2012 is de raming 3 kiloton hoger dan het maximum en bij voortzetting van huidig beleid zal het 4 –tot 6 ton hoger uitkomen (Planbureau voor de Leefomgeving).

Oorzaken: pluimvee- en varkenshouders hebben uitstel van maatregelen gekregen
mestverwerkingsprodukten verdringen kunstmest in de Nederlandse landbouw

Challenge the future

Botanische Tuin TU Delft, Afdeling Biotechnologie,
Faculteit Technische Natuurwetenschappen

 TU Delft

Waarom is reductie van ammoniak nodig?

Gerealiseerde en geraamde emissies van ammoniak in Nederland

Sector	1990	2000	2008	2012	Raming 2010 (vastgesteld beleid)	Raming 2020 (vastgesteld beleid)	NEC- plafond vanaf 2010
Industrie	5	3	2	2	2	2	
Raffinaderijen	8	7	0	0	0	0	
Energiesector	0	0	0	0	0	0	
Afvalverwerking	0	0	0	0	0	0	
Verkeer	1	3	2	2	2	2	
Landbouw	238	140	114	118	116	102	
Huishoudens	9	7	8	8	9	9	
HDO en Bouw	3	3	3	3	3	3	

WELKE OPLOSSING?



Creëren micro water druppels door electro spraying of ultra trilling verdamping

+

Ammoniak leiden uit een stal door het GASNACA®reductie systeem, dus door water druppels met ammonia absorptie en elektrische afvangst.

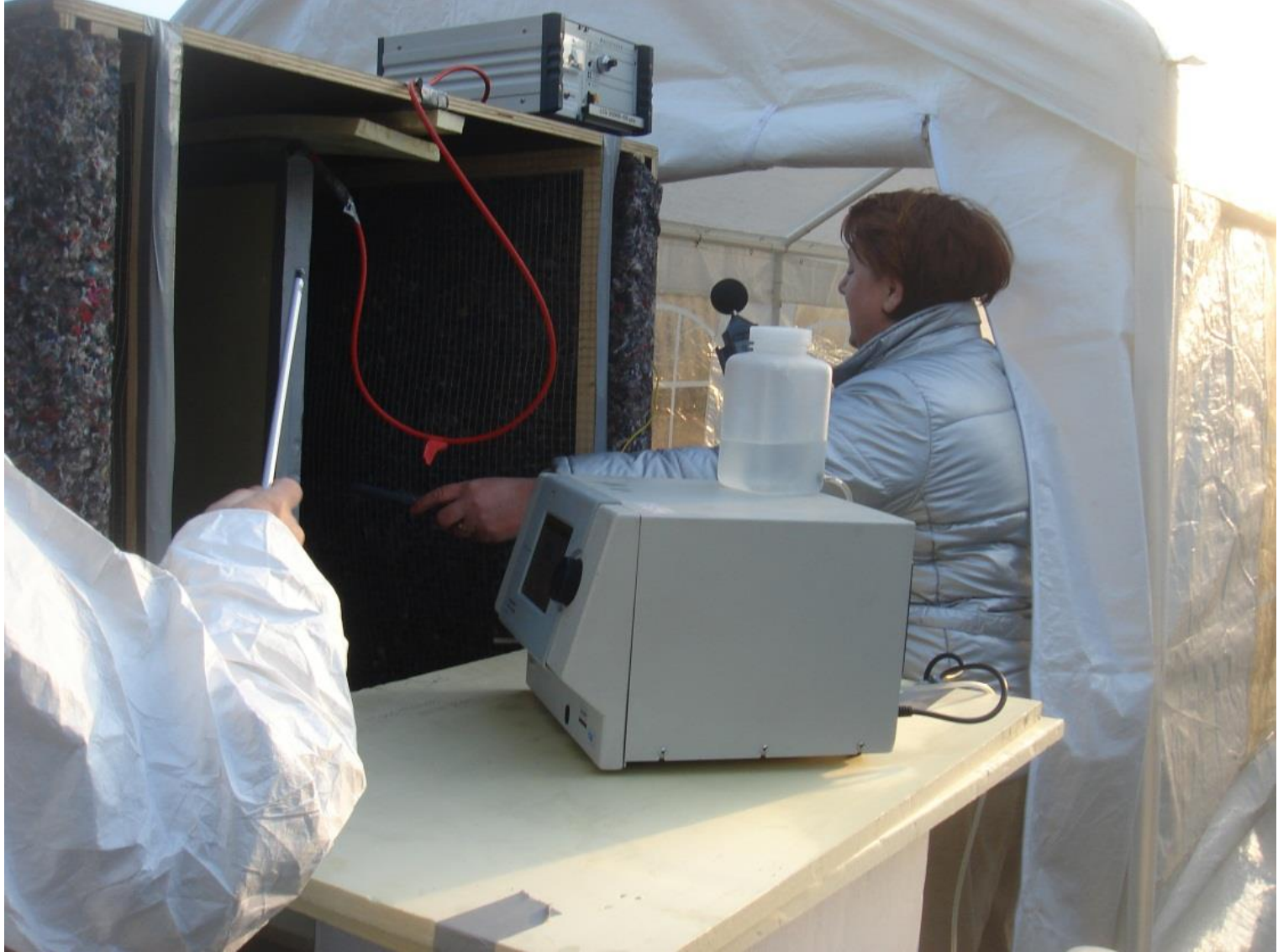

Na behandeling was bijna 100% (99,9999 %) ammoniak reductie

Botanische Tuin TU Delft, Afdeling Biotechnologie,
Faculteit Technische Natuurwetenschappen



Taxus baccata



Het melken van taxol uit naalden (*Taxus*, *Cephalotaxus*, *Wollemia*) Elektrostatische hydrodynamische atomisering (EHDA) maakt mini druppels van plant-vloeistoffen in de lucht en bevatten basisstoffen voor o.a. anti tumor middelen: Taxol® and Taxotere®

→ Duurzaam melken van taxus zonder plant aantasting

→ Bescherming van bedreigde taxus species uit o.a. Noord Amerika (*Taxus brevifolia*) en Japan (*Taxus wallichiana*)







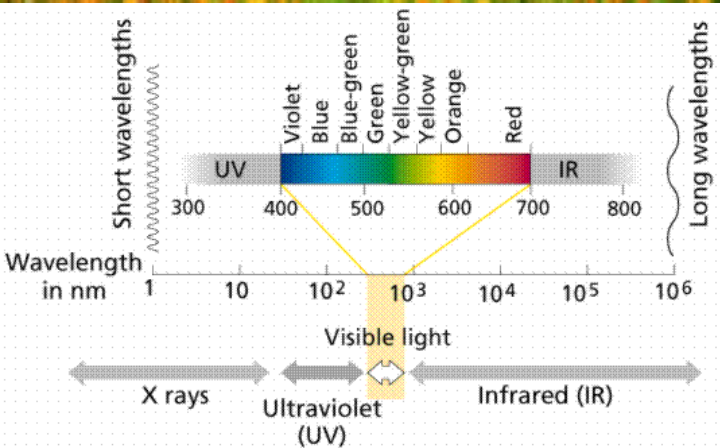

Zichtbaar licht bestaat uit fotonen tussen 400 tot 800 nm.

- Blauw licht (400 – 500 nm) 21 %
- Groen licht (500 – 600 nm) 26 %
- Rood licht (600 – 700 nm) 27 %
- Verrood licht (700 – 800 nm) 26 %



Challenge the future



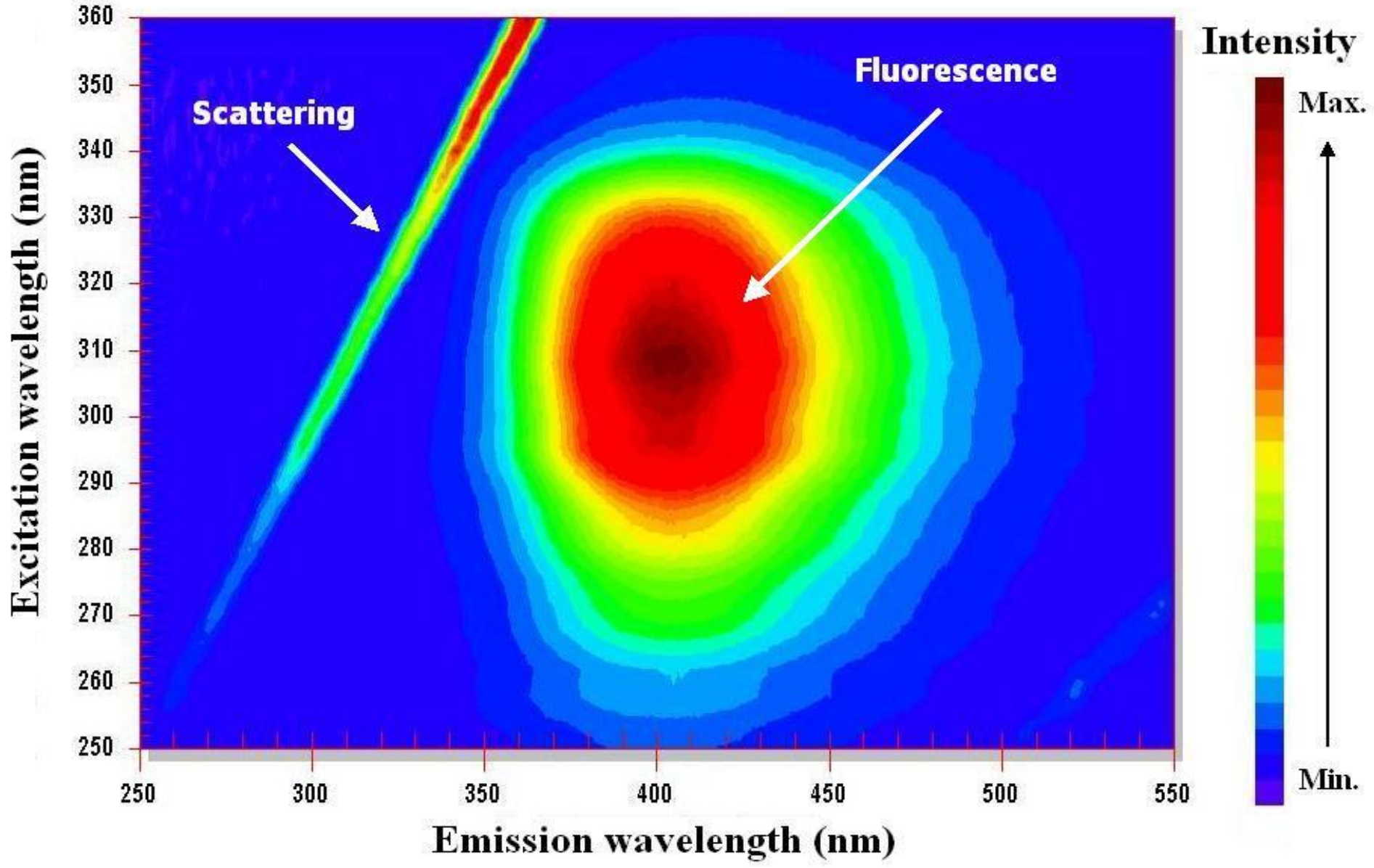

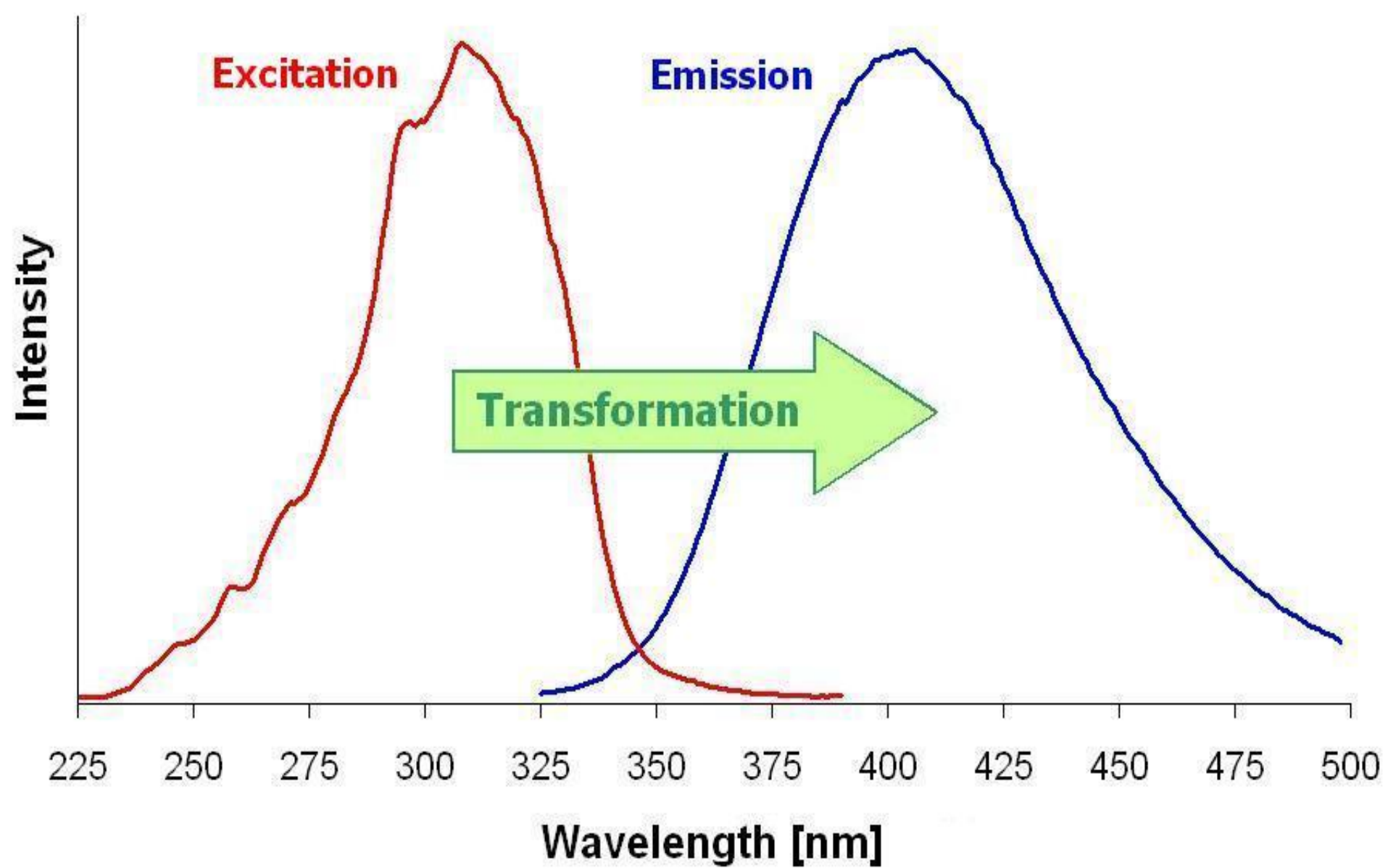

BIOSYNTHETISCH PROCES: EEN NIEUW BIOLOGISCH UV FILTER

WAX COMPONENTS OF NEEDLES OF MOUNTAIN PINE (*Pinus mugo mughens*)

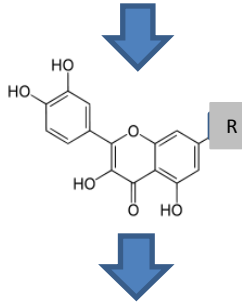

3 detected optically bioactive flavonoids

Structure
Physical properties
Analytics (detection and quantification)

Elucidation of biosynthetic pathway

Genome sequence. Sequencing two cultivars exhibiting differential production of flavonoids. Lowland cultivar does not produce the compound of interest while highland cultivar produces it. cDNA sequence. Substracted cDNA library sequencing
Draft genome sequence and annotations in silico
identification of potential genes involved in flavonoid pathway.
Cloning of cDNA encoding putative optically bioactive flavonoid specific genes.



BAKERS YEAST (*Saccharomyces cerevisiae*)

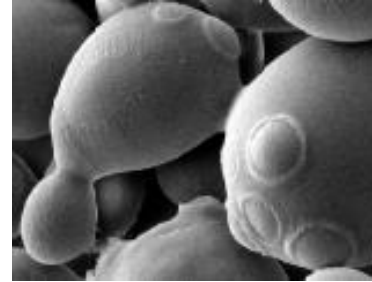

Bakers yeast (*Saccharomyces cerevisiae*)

The ability of *S. cerevisiae* to be transformed with and stably maintain large sequences of DNA has long made it a workhorse for genome sequencing efforts. The central technique for building large heterologous DNA constructs in yeast is transformation associated recombination (TAR), which leverages yeast's unique capability to efficiently combine many DNA fragments by homologous recombination in a single step.



To produce optically bioactive flavonoids, a proper yeast metabolic chassis has been created in the frame of the PGSB. The metabolic chassis was optimized to improve precursor biosynthesis; pathways leading to the synthesis of the precursors necessary for optically bioactive flavonoid synthesis, i.e. phenylalanine {Luttik, 2008 1485 /id} and malonyl-CoA, in the meantime pathways for phenylalanine degradation were blocked. Enginering pathway in *S. cerevisiae* with fermentation.

Challenge the future

Botanische Tuin TU Delft, Afdeling Biotechnologie,
Faculteit Technische Natuurwetenschappen



The logo for TU Delft, featuring a stylized flame or leaf symbol above the text 'TU Delft'.

Delft
University
of
Technology

Novel solar power cell with bio UV translucent thin film coating on/in a solar power cell.

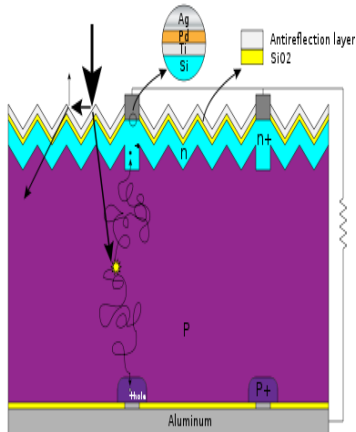
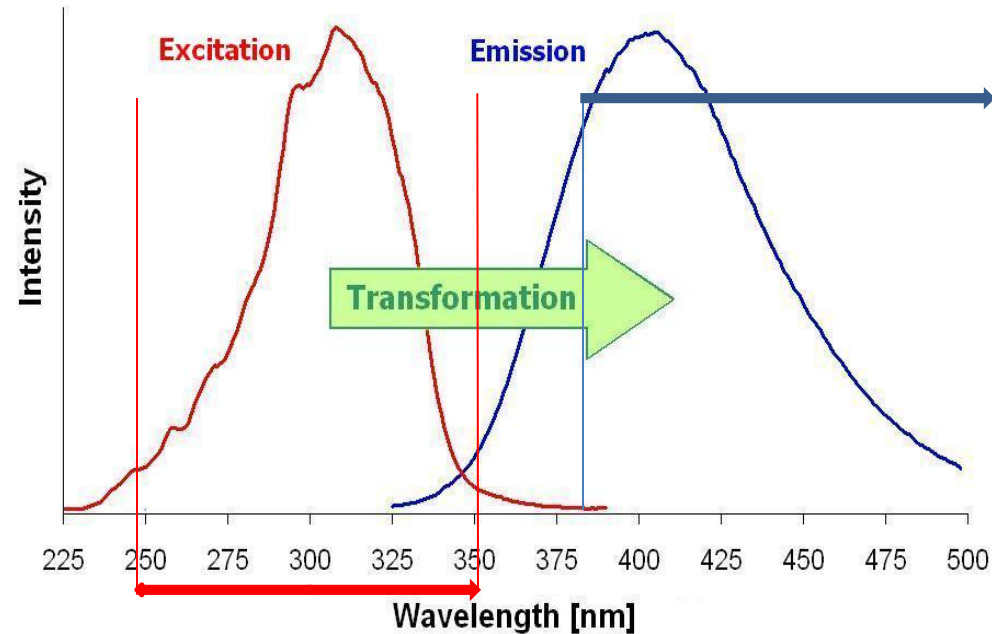

+ Novel bio UV translucent

At least provide an increase with 3 percent (integral calculation) as useful UV light efficiency
 Solar radiation starts at wavelengths of 380 nm or more for energy production in a solar power cell.

Results:

At least a + 20% energy production and a longer lifespan, much more than present (\approx 21yrs)

Challenge the future

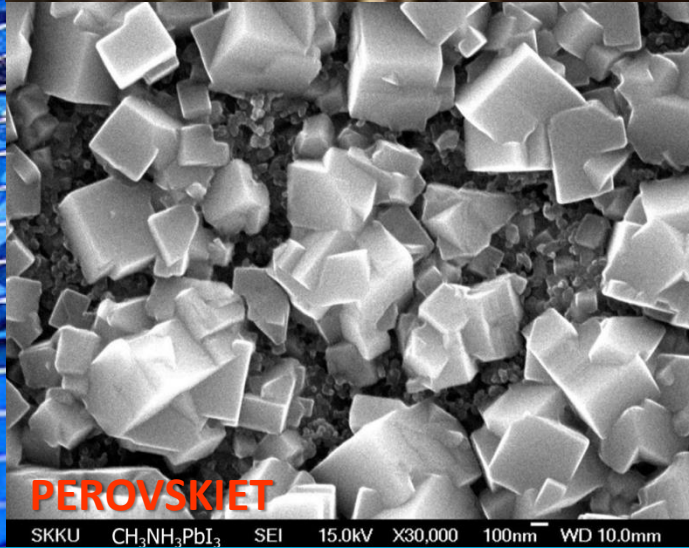

Challenge the future



Delft
University
of
Technology

Botanische Tuin TU Delft, Afdeling Biotechnologie,
Faculteit Technische Natuurwetenschappen

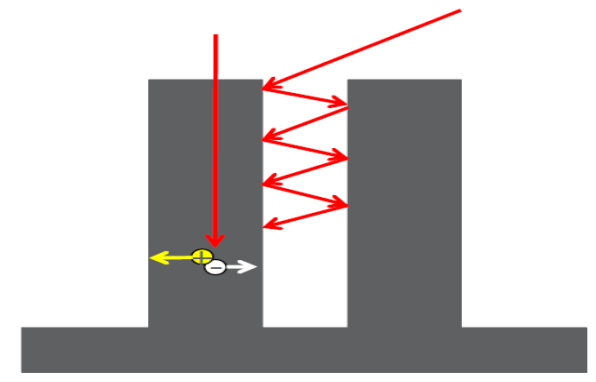
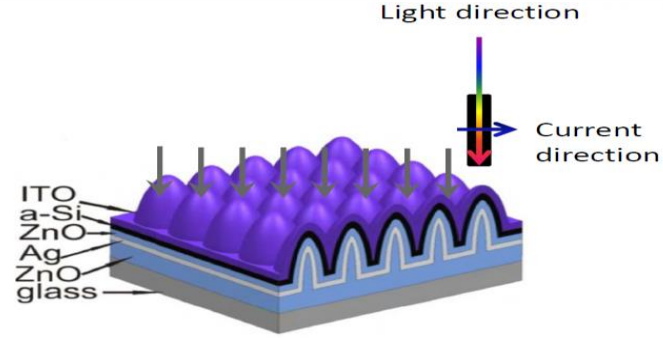
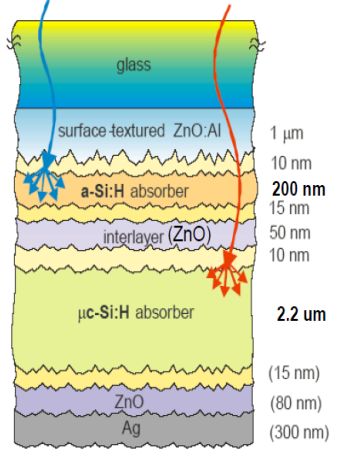

SUPER scattering!

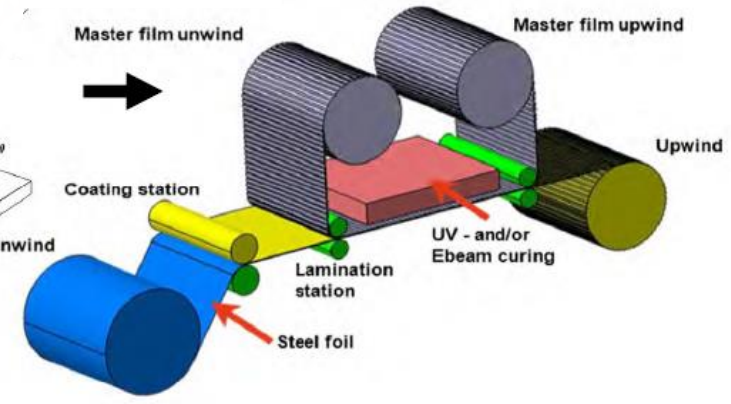
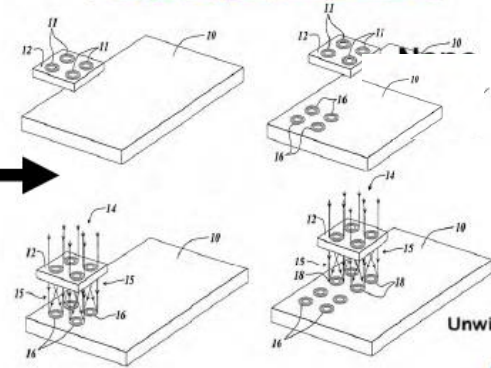
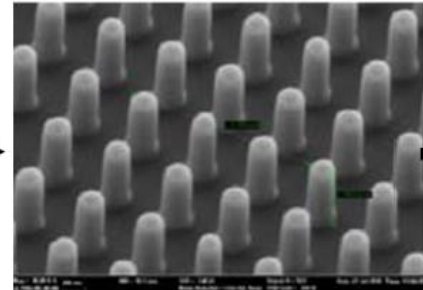
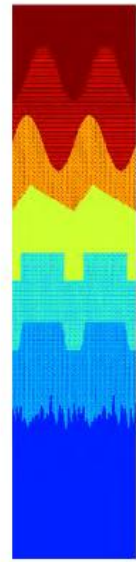
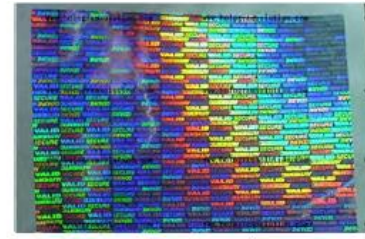

1. Modeling

2. Mastering

3. Tooling

4. Imprinting

Challenge the future



Cosmetics



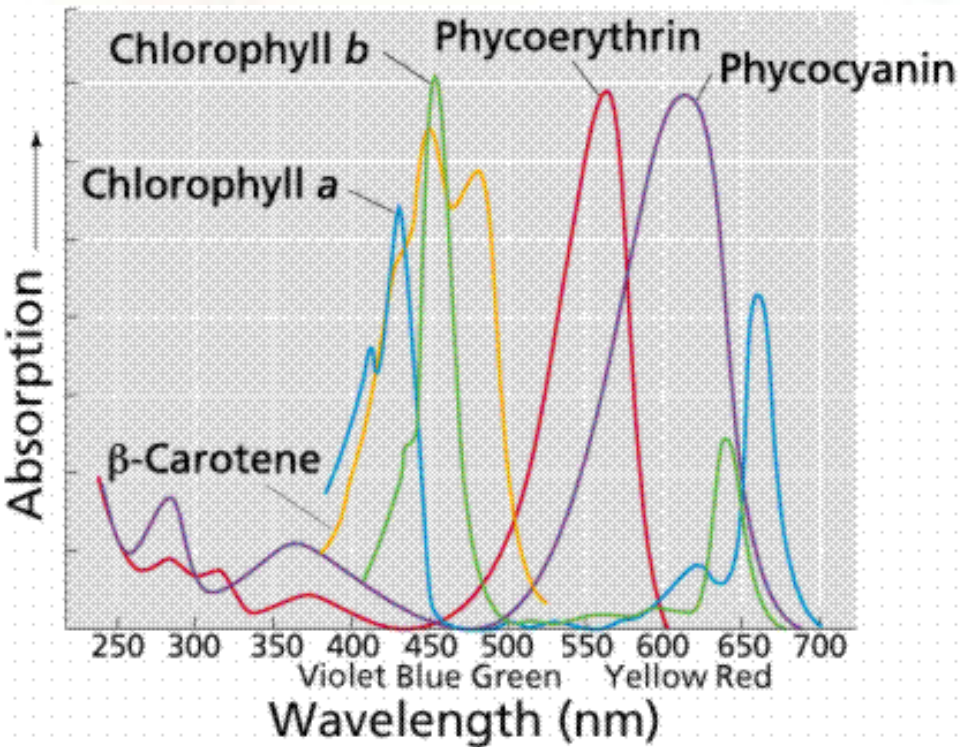

Planten benutten blauw tot verrood licht. Donker groene bladen hebben minder blauw licht nodig en meer verrood licht, terwijl licht groene bladen blauw en rood licht nodig hebben voor de fotosynthese. Het phytochroom is een bio chromatische foto-receptor met een absorptie optimum in het rood en verrood spectrum. De ratio tussen deze bepalen plantenprocessen, zoals kieming, bloemknop ontwikkeling, cel strekking in de stam en veroudering.



Challenge the future

TU Delft

Delft
University
of
Technology

RODE EN BLAUWE LED TECHNOLOGIE



Challenge the future

Botanische Tuin TU Delft, Afdeling Biotechnologie,
Faculteit Technische Natuurwetenschappen

TUDelft

Traditionele licht technology



Een bizar fenomeen dat mij in 2002 op viel tijdens auto rijden van Delft naar Amsterdam..

Future licht met LED's



Challenge the future

Botanische Tuin TU Delft, Afdeling Biotechnologie,
Faculteit Technische Natuurwetenschappen

 TU Delft

LED licht!

Maar hoe & welk licht?

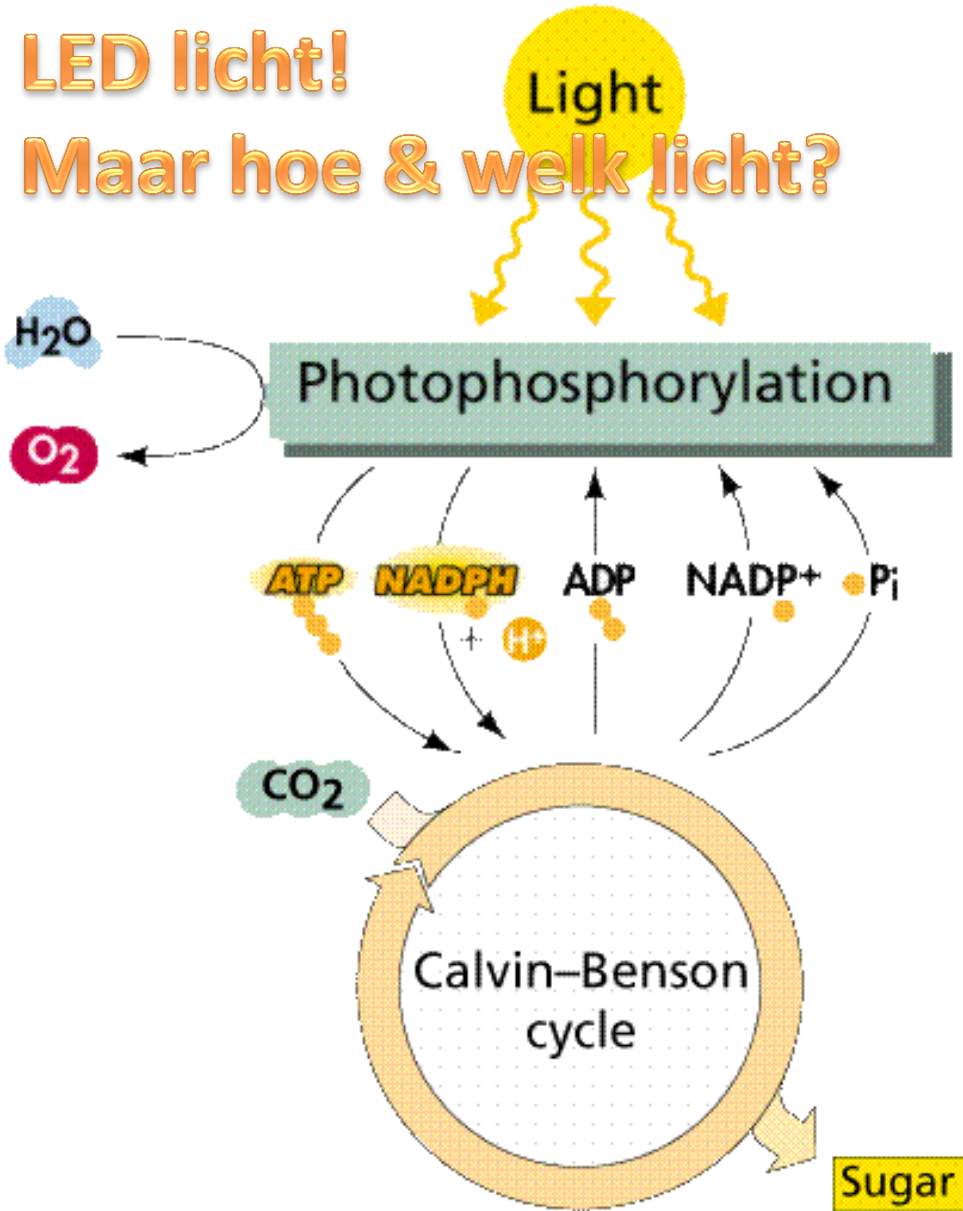

200 – 280 nm UVC ultraviolet is extreem schadelijk.
280 – 315 nm Bevat schadelijk UVB ultraviolet licht dat kleuren van planten verbleekt.

315 – 380 nm Gebied van UVA ultraviolet licht met geen schade en ook geen groei voor planten.

380 – 400 nm De start van zichtbaar licht spectrum. Het proces van chlorophyl absorptie. UV beschermde plastics blokkeren het licht in dit golfgebied.

400 – 520 nm Dit gebied bevat violet, blauw, en groene golflengten. Het is de piek absorptie van chlorophyl, en heeft een zeer grote invloed op de fotosynthese. (bevordert vegetatieve groei).

520 – 610 nm Deze golflengte bevat groen, geel, en oranje licht en vertonen bijna geen fotosynthese absorptie.

610 – 720 nm Dit is het rode gebied. Een hoge absorptie door chlorofyl en van zeer grote invloed op de fotosynthese. (bevordert bloei en knopzetting).

720 – 1000 nm Een geringe absorptie door chlorophyl. Bloei en kieming wordt beïnvloed . Aan het uiterste van deze spectraalband is infrarood, dus uitsluitend warmte.

Challenge the future

TU Delft

Chlorophyll Absorption Spectrum of Visible Light

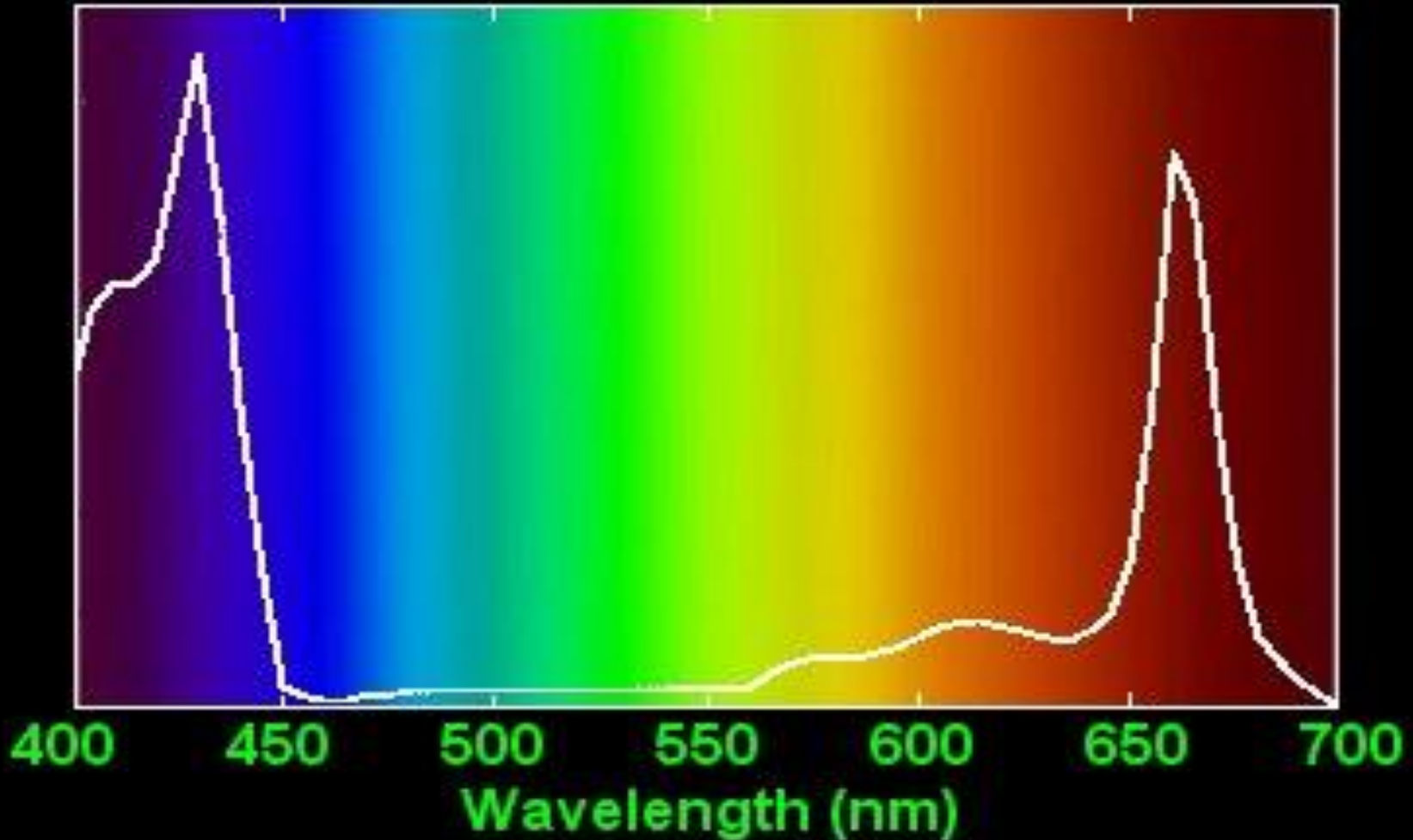

Challenge the future

Botanische Tuin TU Delft, Afdeling Biotechnologie,
Faculteit Technische Natuurwetenschappen

 TU Delft

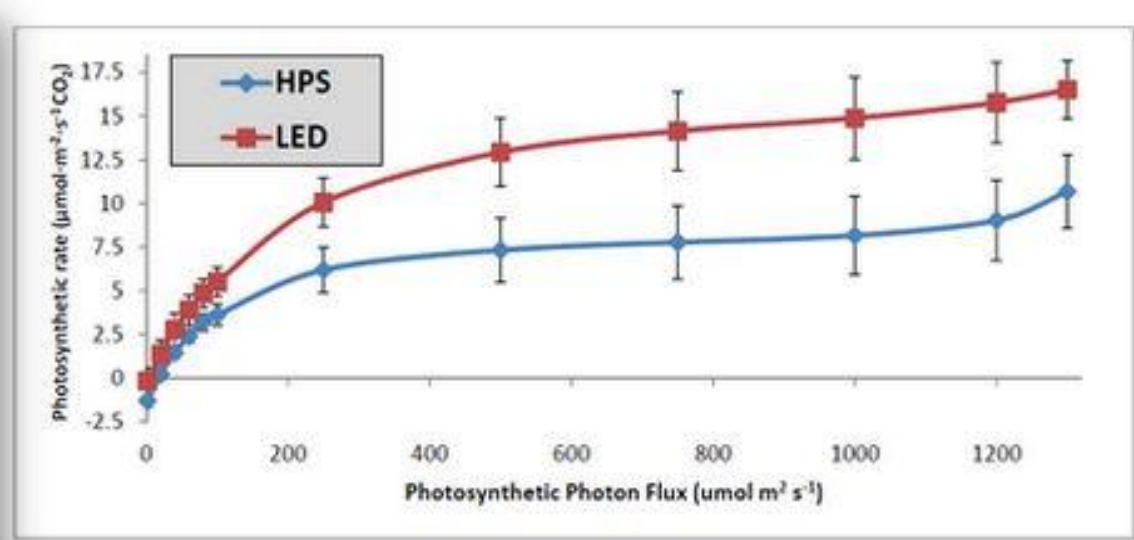
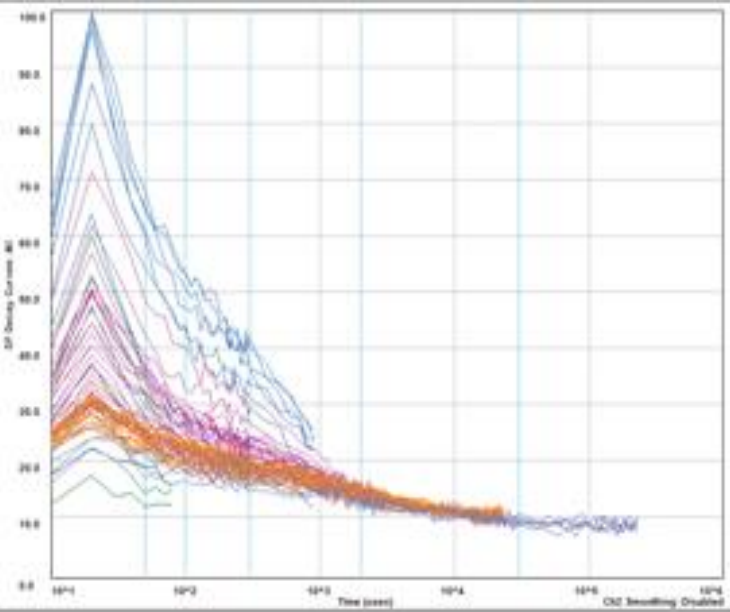
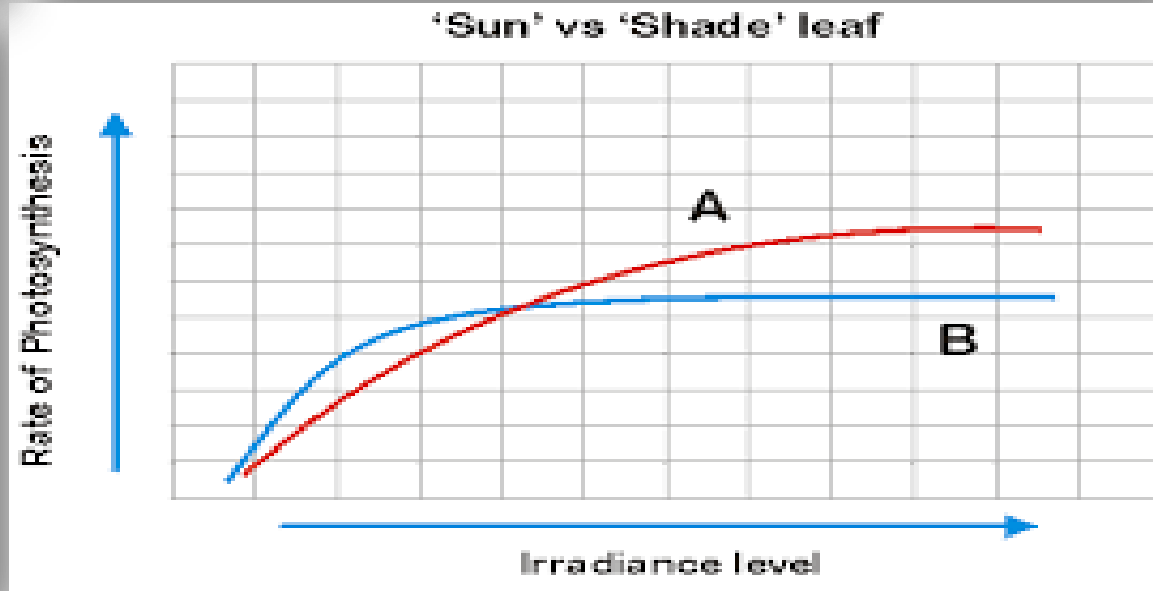
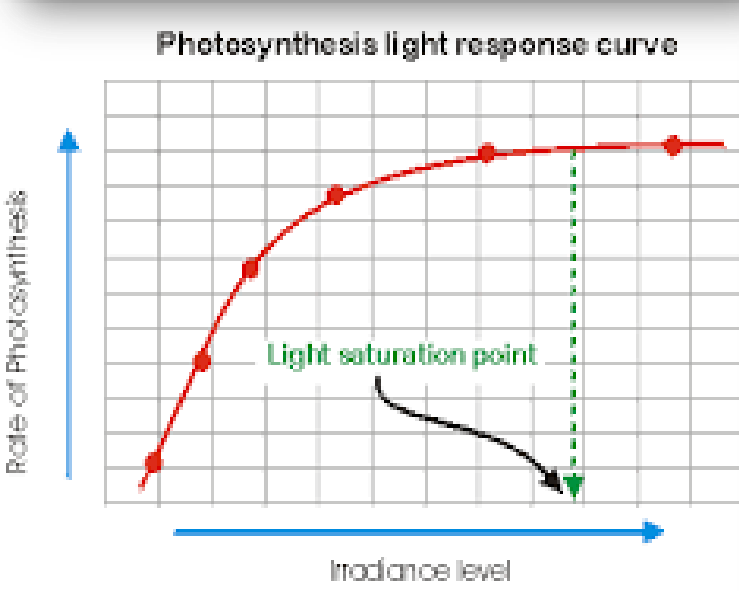
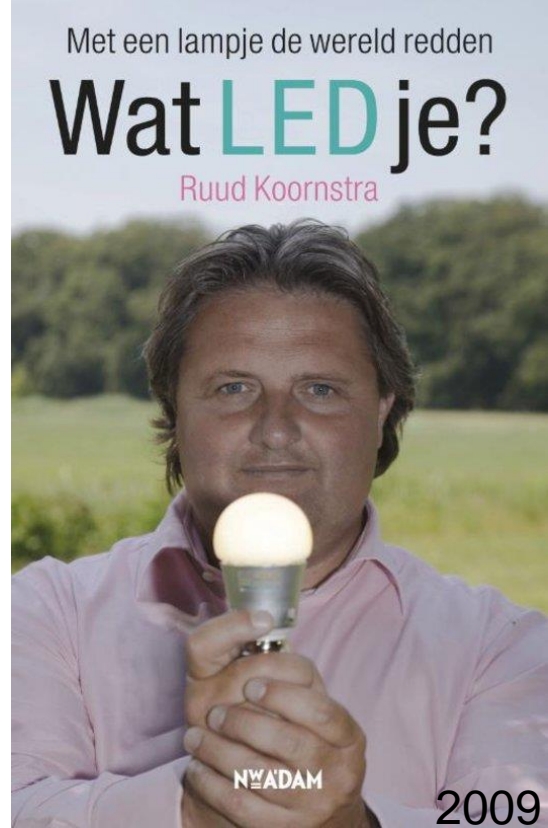

Figure 1: Light curves for gerbera [Terra Saffier cultivar] grown under HPS and LED supplemental lighting



Challenge the future

lemnis lighting PHILIPS



Na groeitesten in 2004 met introductie bij Tendris ➤ Lemnis



Challenge the future

Botanische Tuin TU Delft, Afdeling Biotechnologie,
Faculteit Technische Natuurwetenschappen





WORLD ECONOMIC FORUM GLOBAL INNOVATION AWARD 2010 Challenge the future

Botanische Tuin TU Delft, Afdeling Biotechnologie,
Faculteit Technische Natuurwetenschappen





Challenge the future

Botanische Tuin TU Delft, Afdeling Biotechnologie,
Faculteit Technische Natuurwetenschappen



Close-up of the Retina

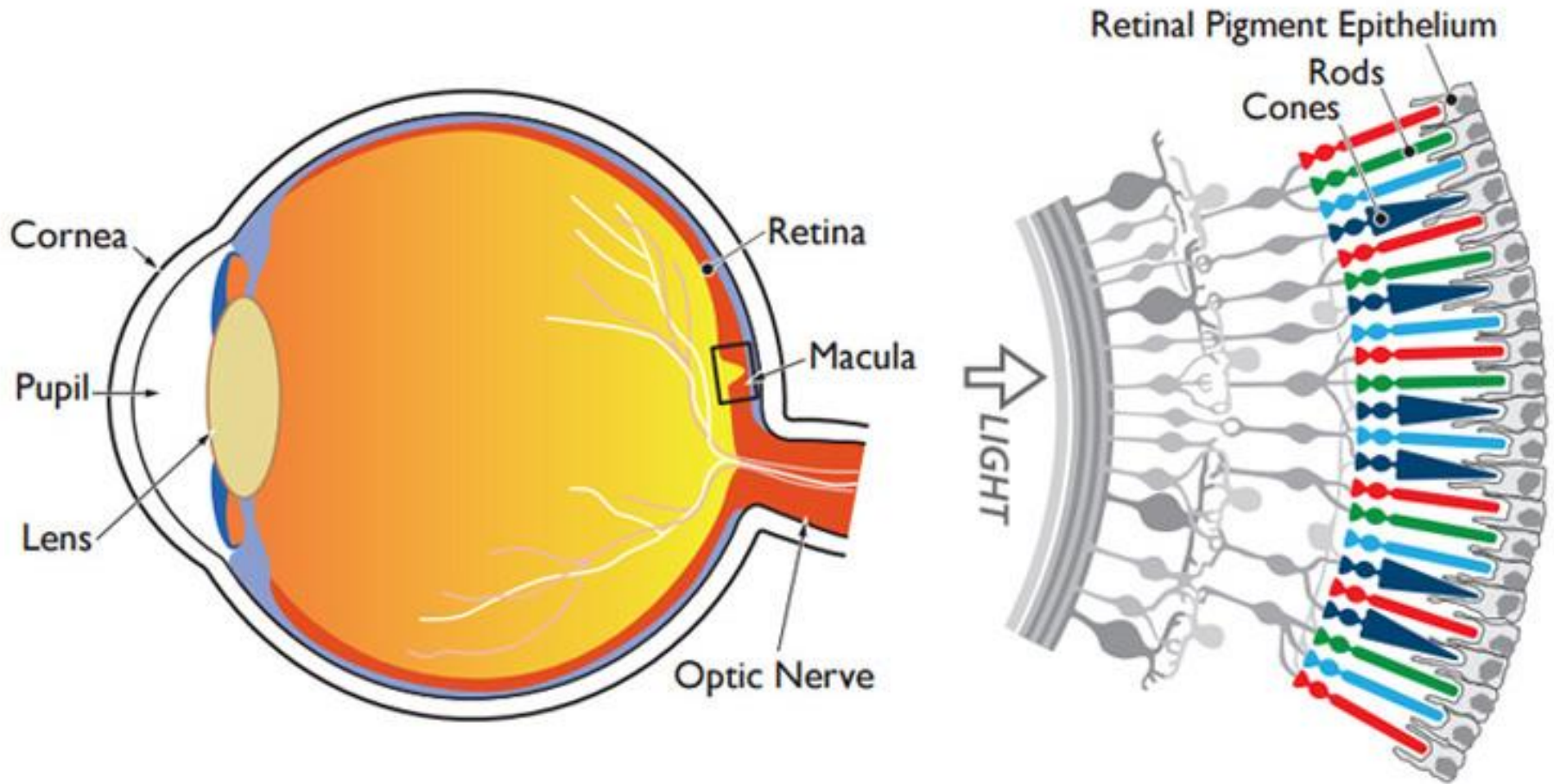

Challenge the future

Botanische Tuin TU Delft, Afdeling Biotechnologie,
Faculteit Technische Natuurwetenschappen

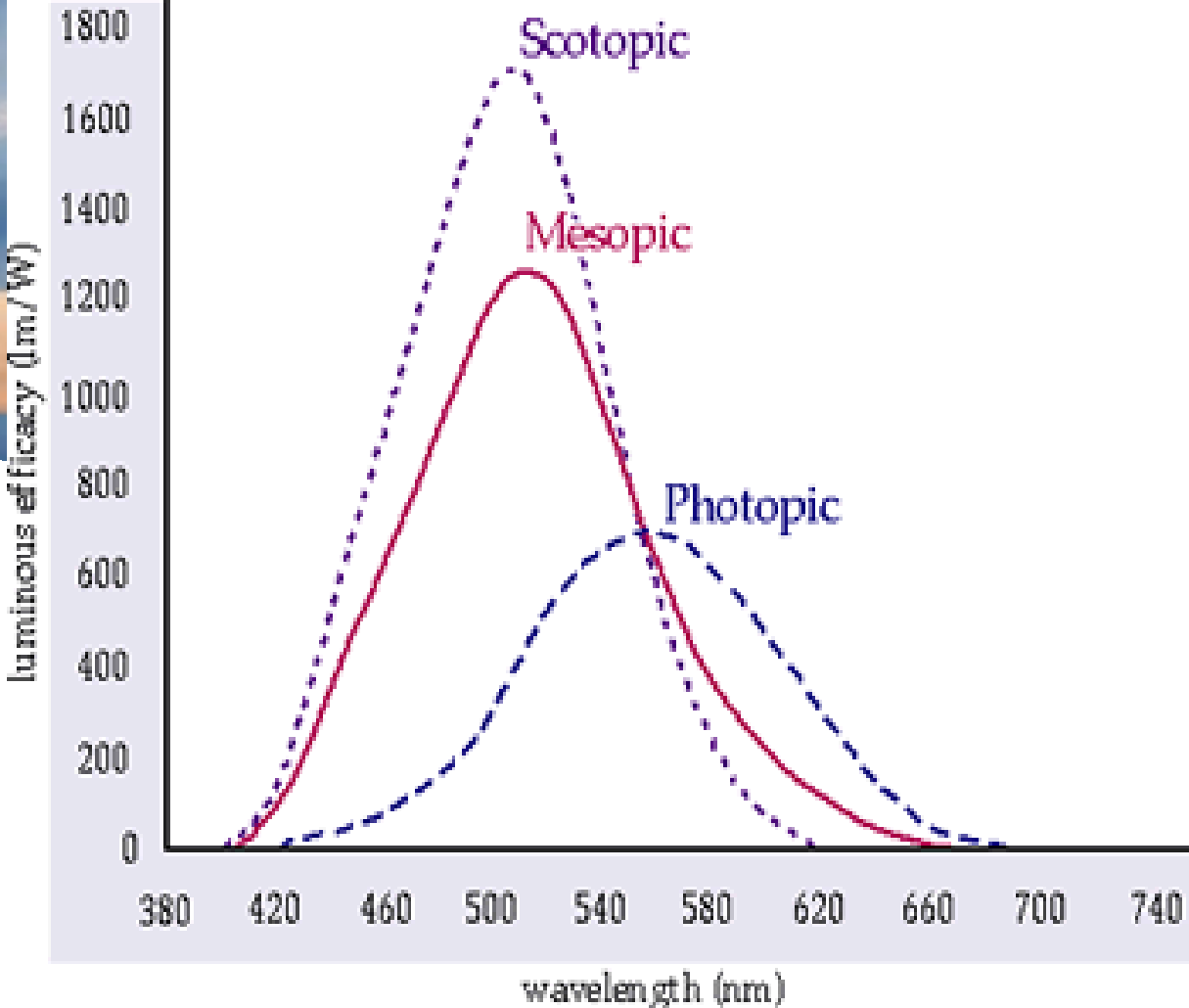
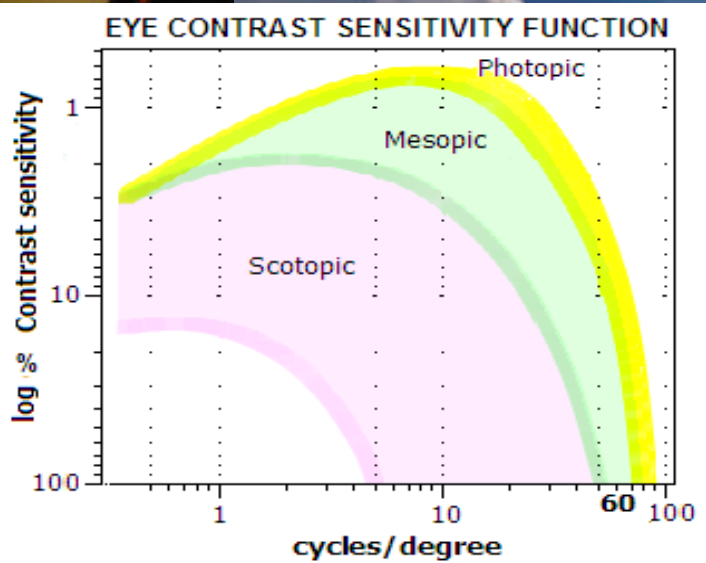

TU Delft



Samen met Lemnis Lighting (Tendris Group) is met de Botanische Tuin TU Delft mesopisch licht voor stallen, kantoorruimten en de huiskamer van de toekomst. Licht waarin je met het gehele netvlies of retina kan kijken d.m.v. versterkt schemerlicht.

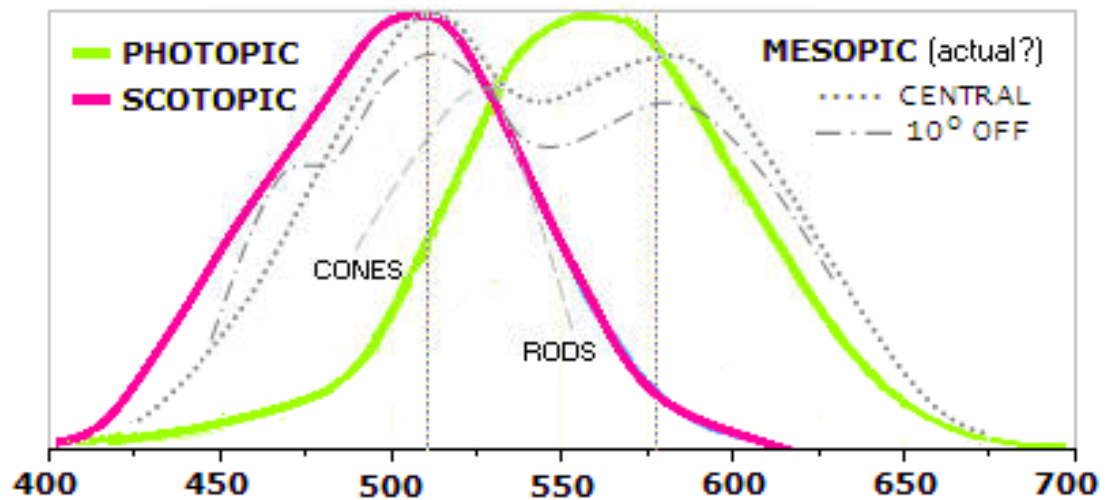
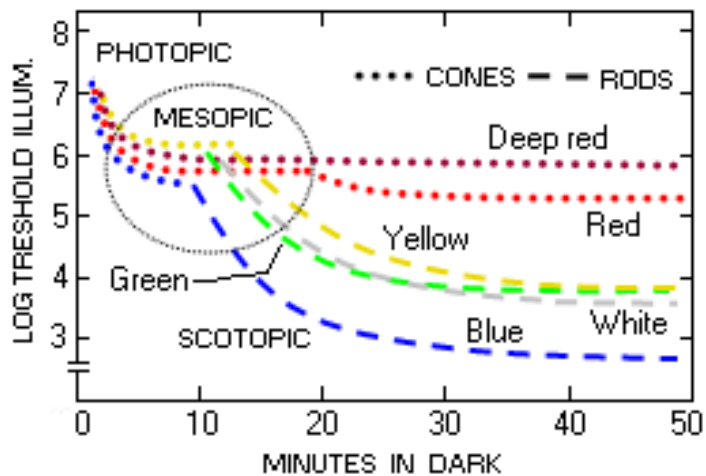
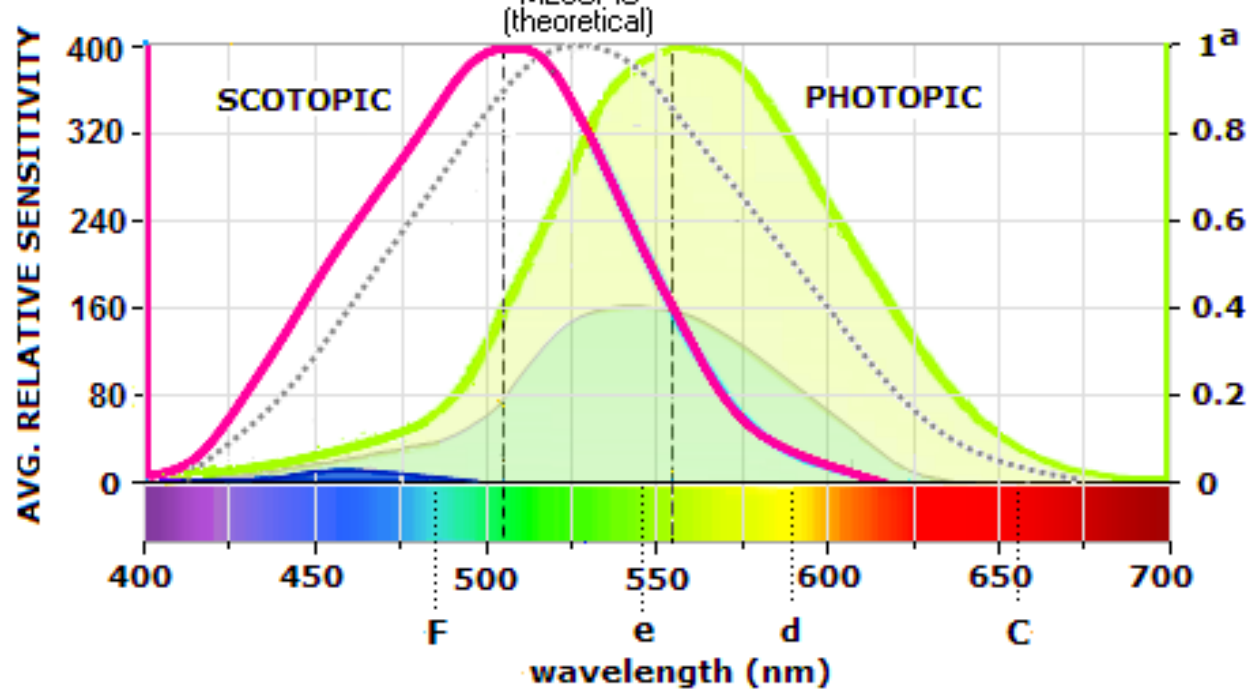
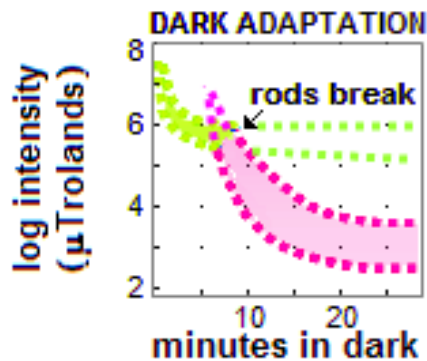
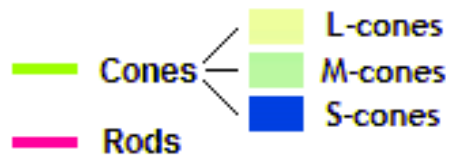

EYE SPECTRAL RESPONSE



Challenge the future

Straatverlichting met mesopisch LED lampen



Straatverlichting met HPS lampen



Challenge the future

Botanische Tuin TU Delft, Afdeling Biotechnologie,
Faculteit Technische Natuurwetenschappen

 TU Delft



Latex → Rubber →



Hevea brasiliensis

Agave sisalana

Vezels → Sisal →

Expansie vat

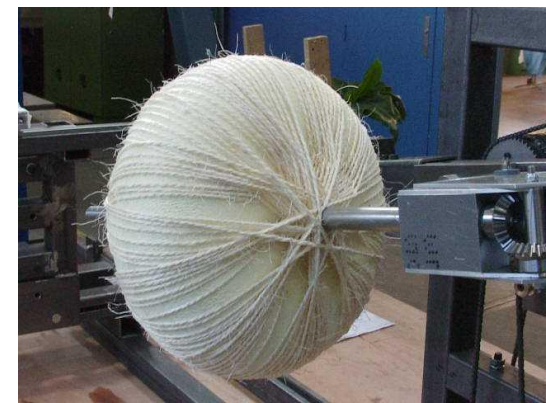



Stoel: sandwich balsa hout kern + plaat van vlas-composiet
Auto-onderdelen (40 %) and Flax Cat
(90%) of natuurlijke vezel-composieten



Biobased auto reparatieve materialen/ self healing materials

Biobased Autoreparatieve materialen gebaseerd op oleoharsen, oleogommen, cis- en trans-latex, pectucelluloze

Op basis van plantenvezels wordt self healing ook mogelijk

Het moet leiden tot zelfhelende materialen voor bijvoorbeeld bedekking, of als constructiemateriaal..

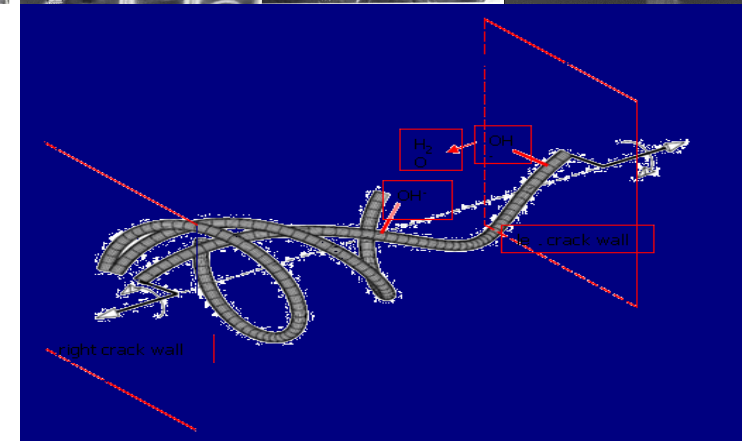
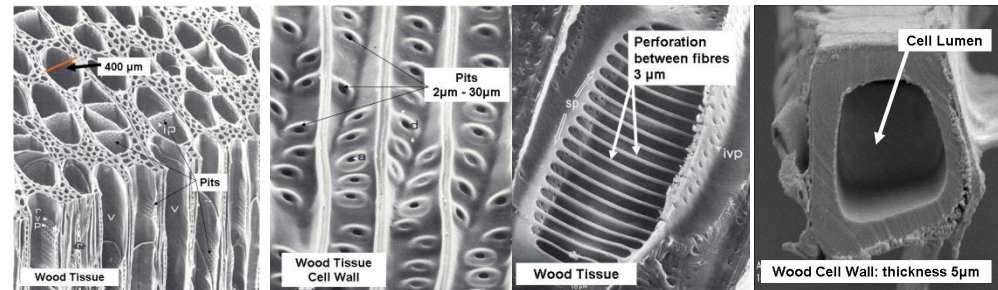

Recovery of deformation during wetting of wood

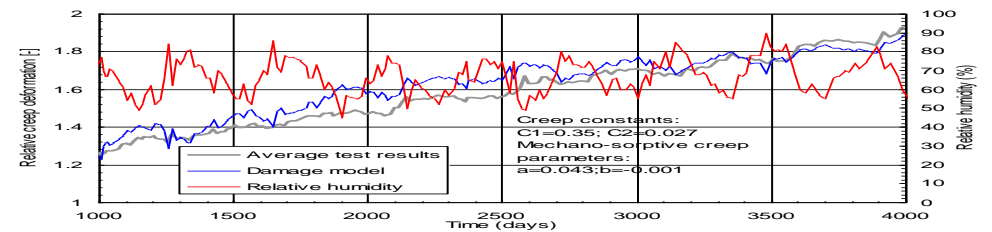

Misvorming en herstel door toename van vochtigheid in vezels.

Beton mix-structuur en faalsysteem van grote en kleine scheuren

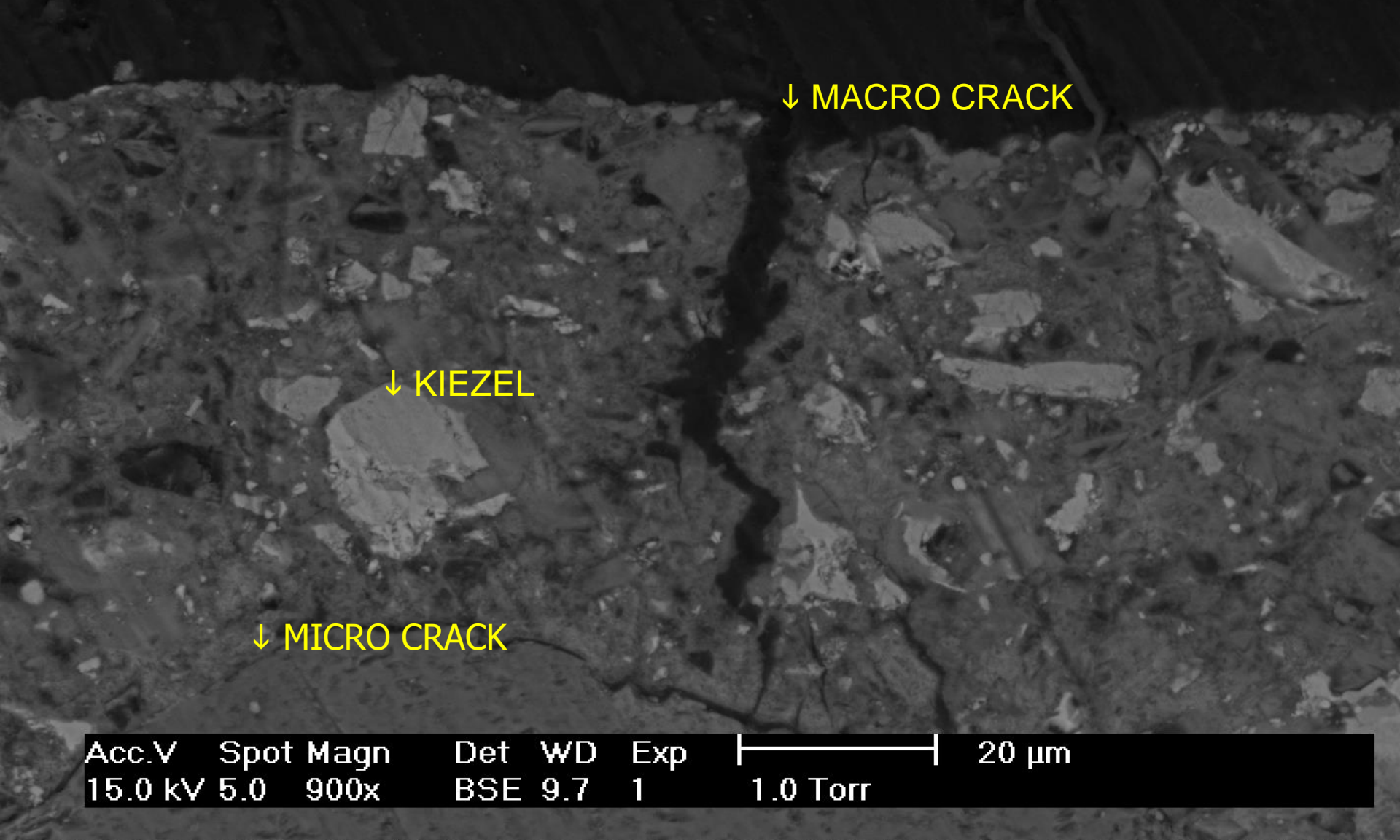

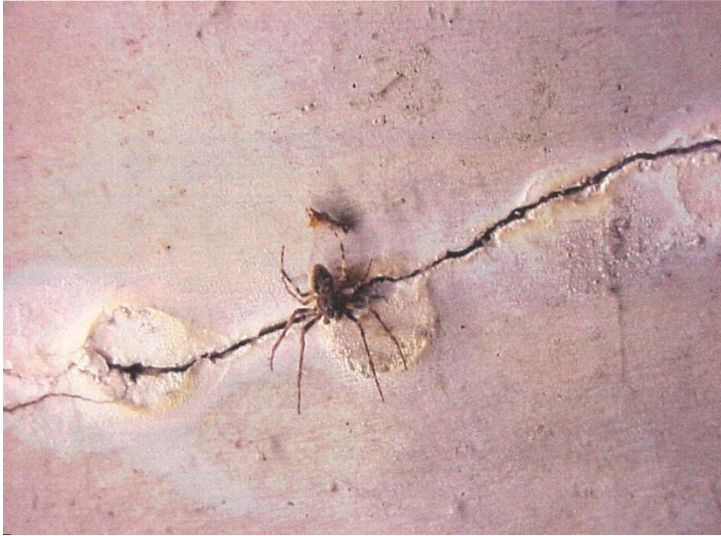

Bij een micro crack komt er water binnen het beton en zet uit bij vriezen en vergroot de scheur. Kooldioxide evaporeert aan de lucht en zwaveldioxide heeft toegang tot de scheuren. Gips wordt gevormd. Dit het betonrot.

Het self healing systeem bestaat uit het binden van de kooldioxide en het sluiten van de scheuren.

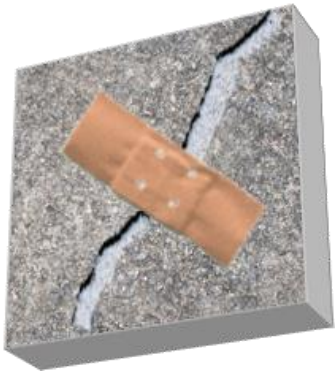

Gelignificeerde vezel van naaldbomen zijn hol en hebben zogenaamde hofstippels ofwel gaatjes. Via de hofstippels is radiair transport mogelijk, vandaar dat naaldbomenhout geïmpregneerd kan worden en loofbomen hout niet.

MAAR HOE ?

SELF HEALING GELIGNIFICEERDE BIO-VEZELS

1. Isolatie van de bio-vezel met water of een loog (NaOH)
2. Vul de holle bio-vezel via vacuüm injectie met ijzerhydroxide
3. Droog de bio-vezel
4. Seal de bio-vezel met pectucelluloze
5. Droog de bio-vezel
6. Tordeer de bio-vezel tot een 'wokkel'
7. Voeg deze vezel met vulling aan de beton mix

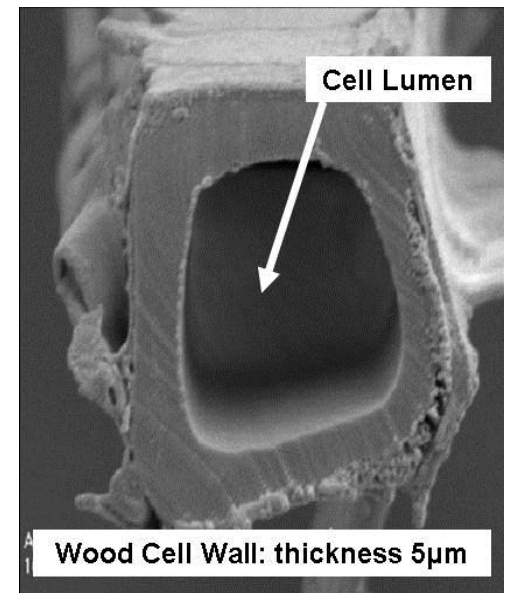
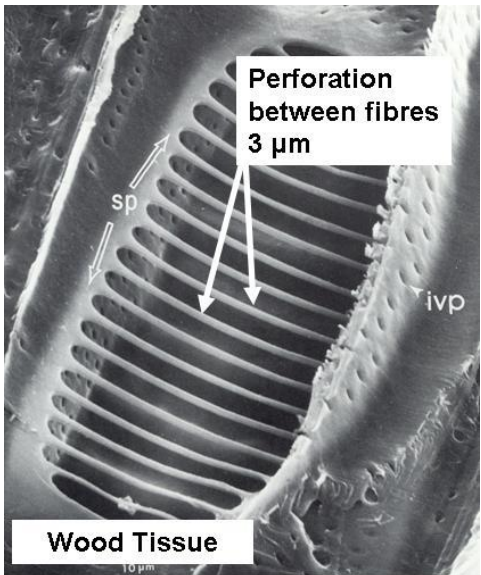
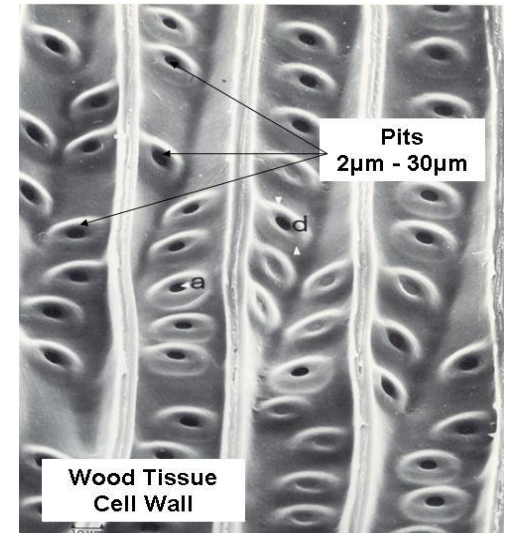
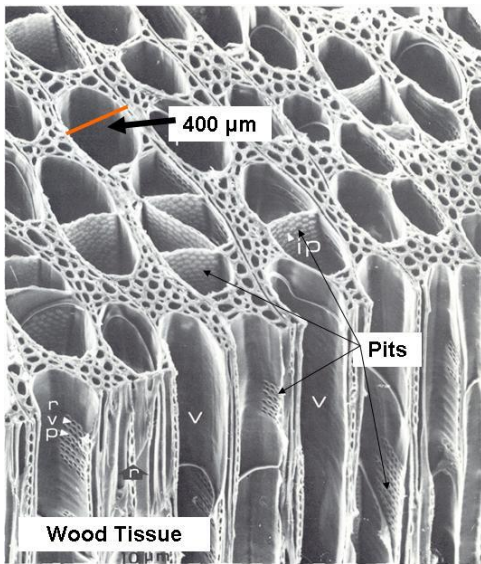

MECHANISCH-SORBETIEF GEDRAG VAN BIO-VEZELS

Recovery of deformation during wetting of wood

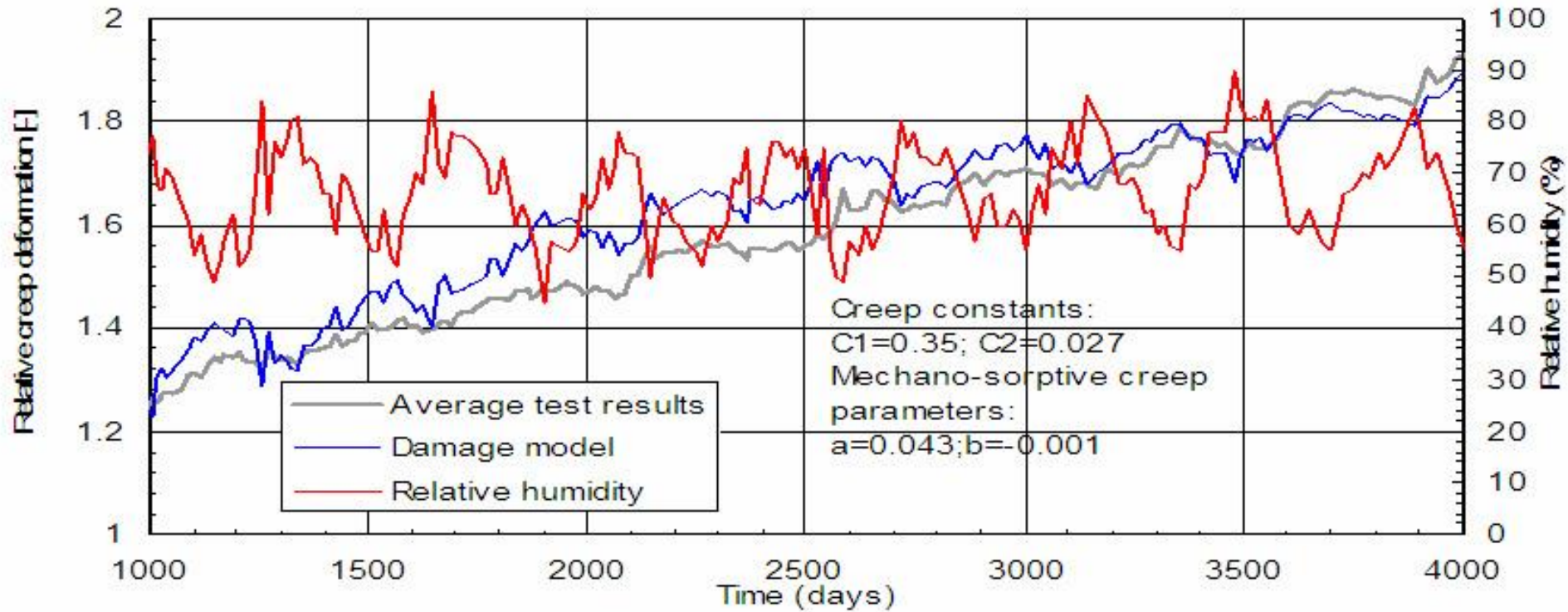

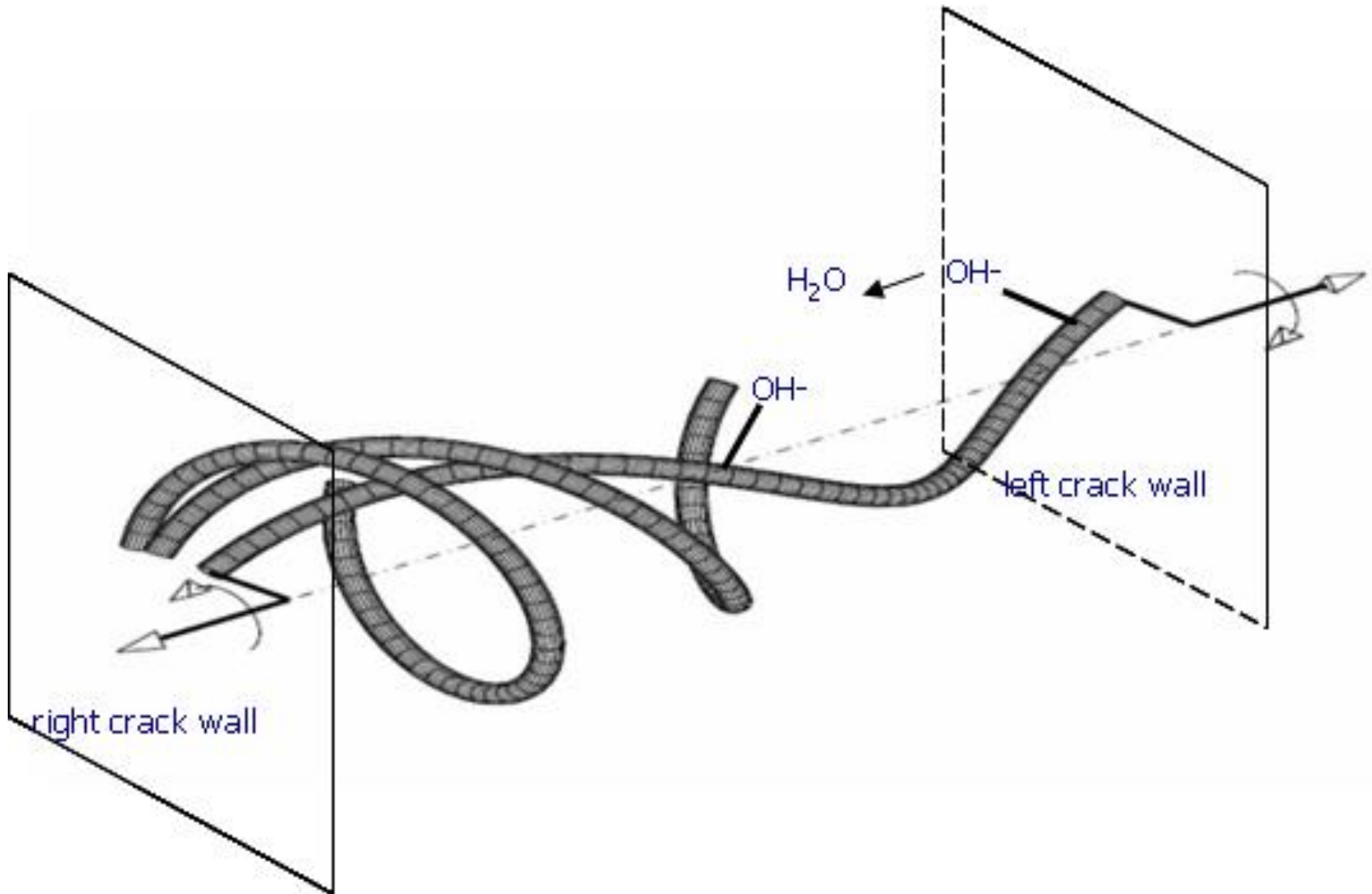

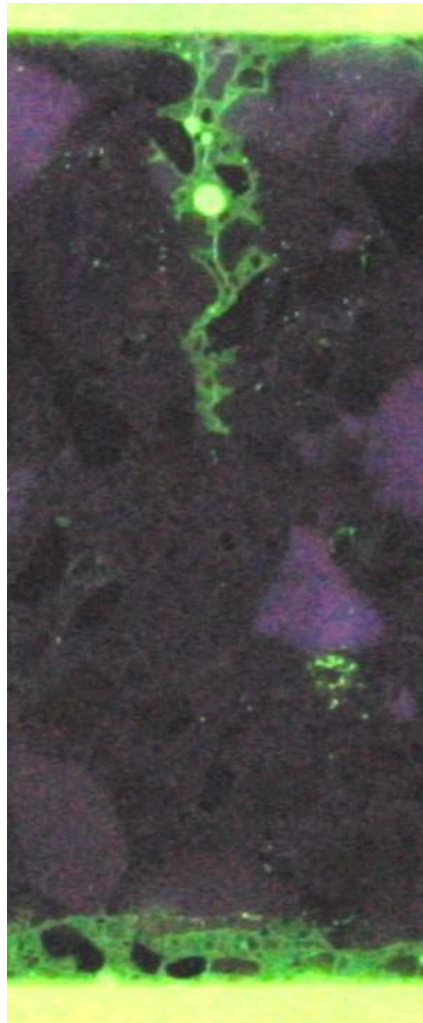

*Before
healing*



*After
healing*



TOEKOMSTIGE PLANTEN TECHNOLOGISCHE OPLOSSINGEN...



Hygroscopisch gestuurde bewegingsystemen



LAUREAAT HOLLANDSCHE MAATSCHAPPIJ VAN WETENSCHAPPEN 2011

Challenge the future

Botanische Tuin TU Delft, Afdeling Biotechnologie,
Faculteit Technische Natuurwetenschappen

 TU Delft

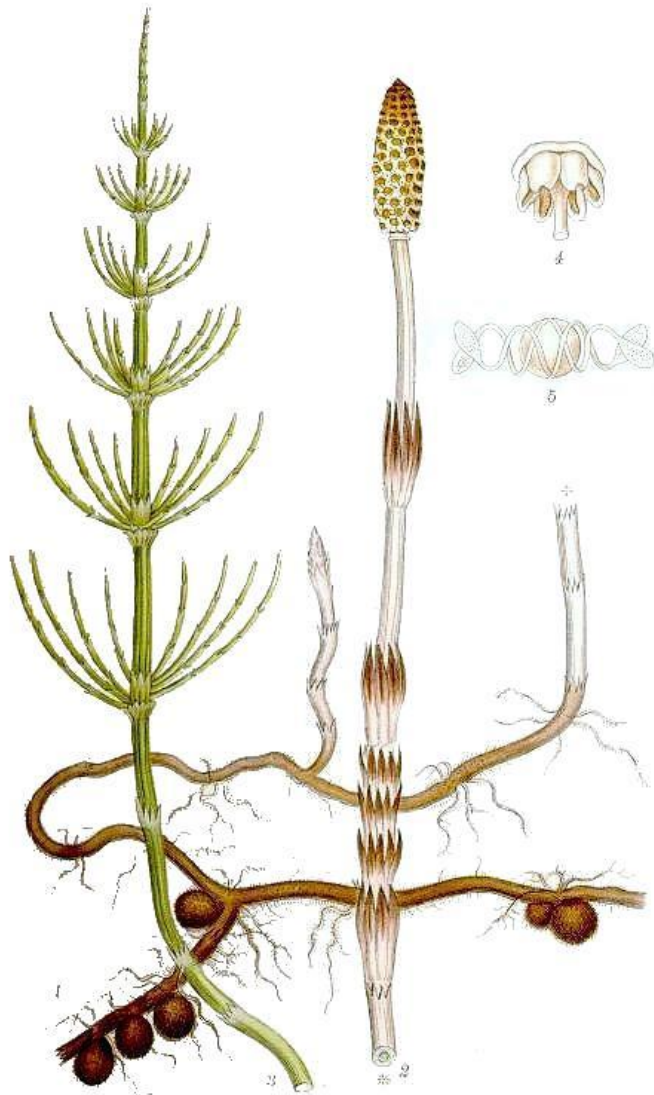

ÅKERFRÅKEN, EUISETUM ARVENSE L.

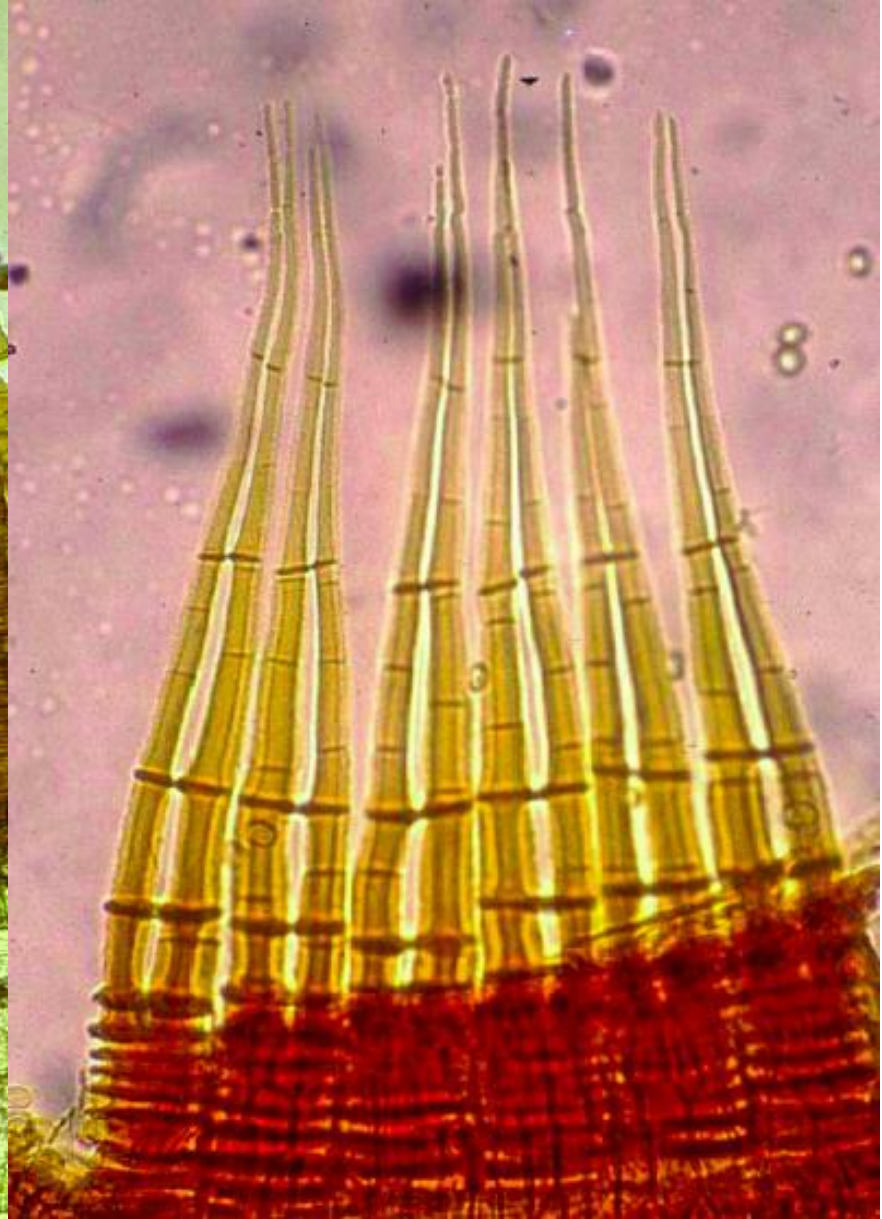
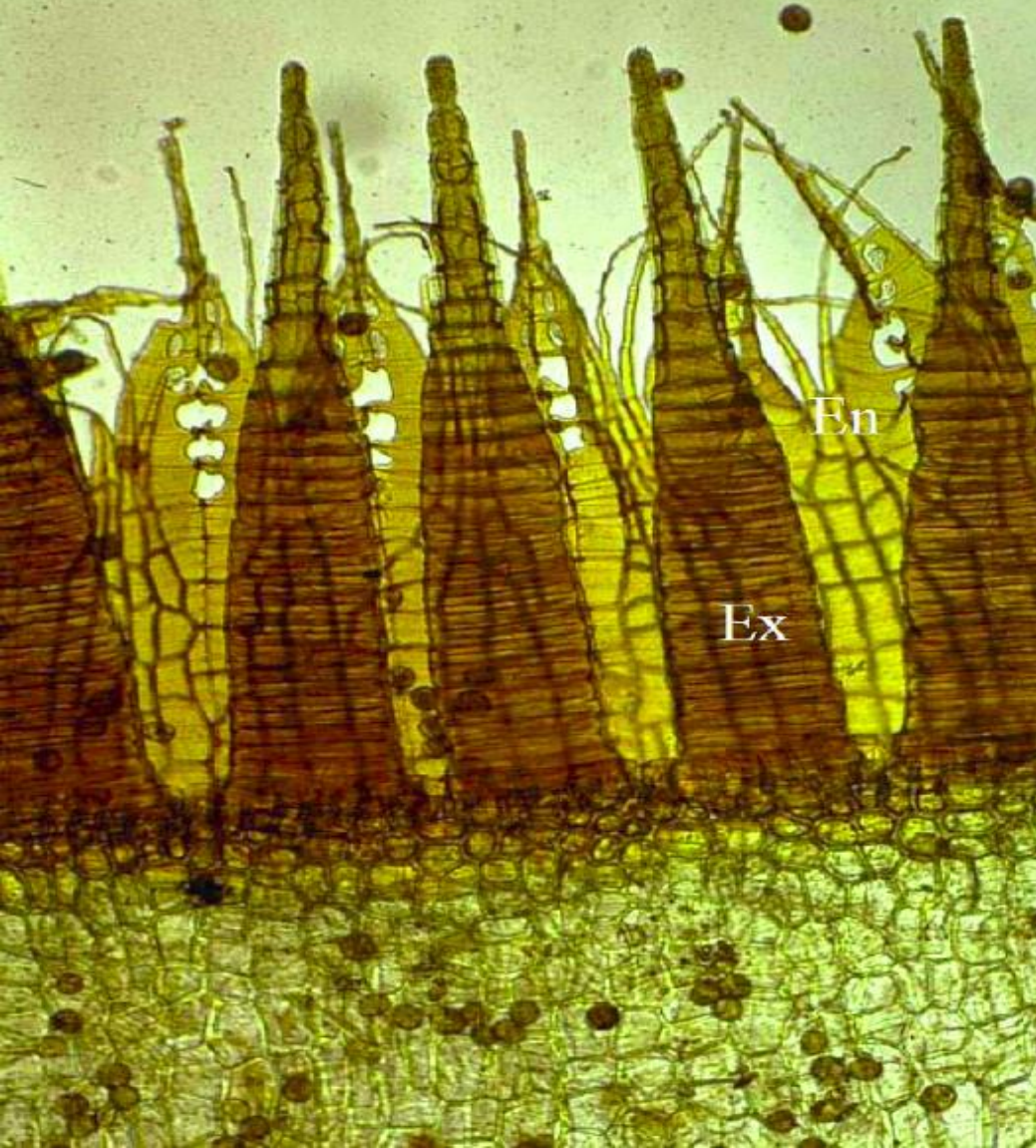

Plate 2.

W. Fitch, del. et lith.

Vircent Brooks, Imp.

Mos persistomen reguleren sporen dispersie



Challenge the future

Botanische Tuin TU Delft,
Afdeling Biotechnologie, Faculteit Technische Natuurwetenschappen

 TU Delft

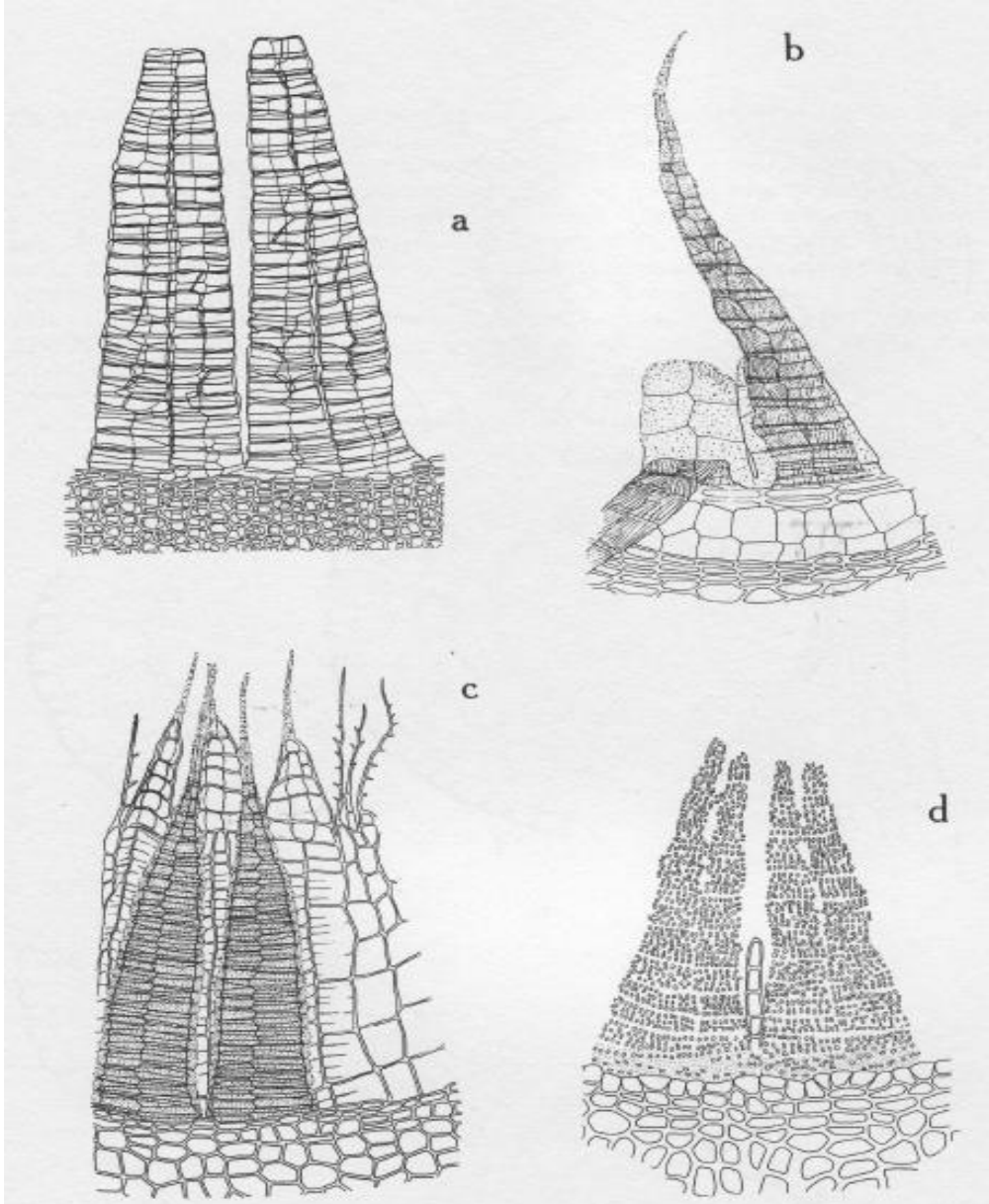
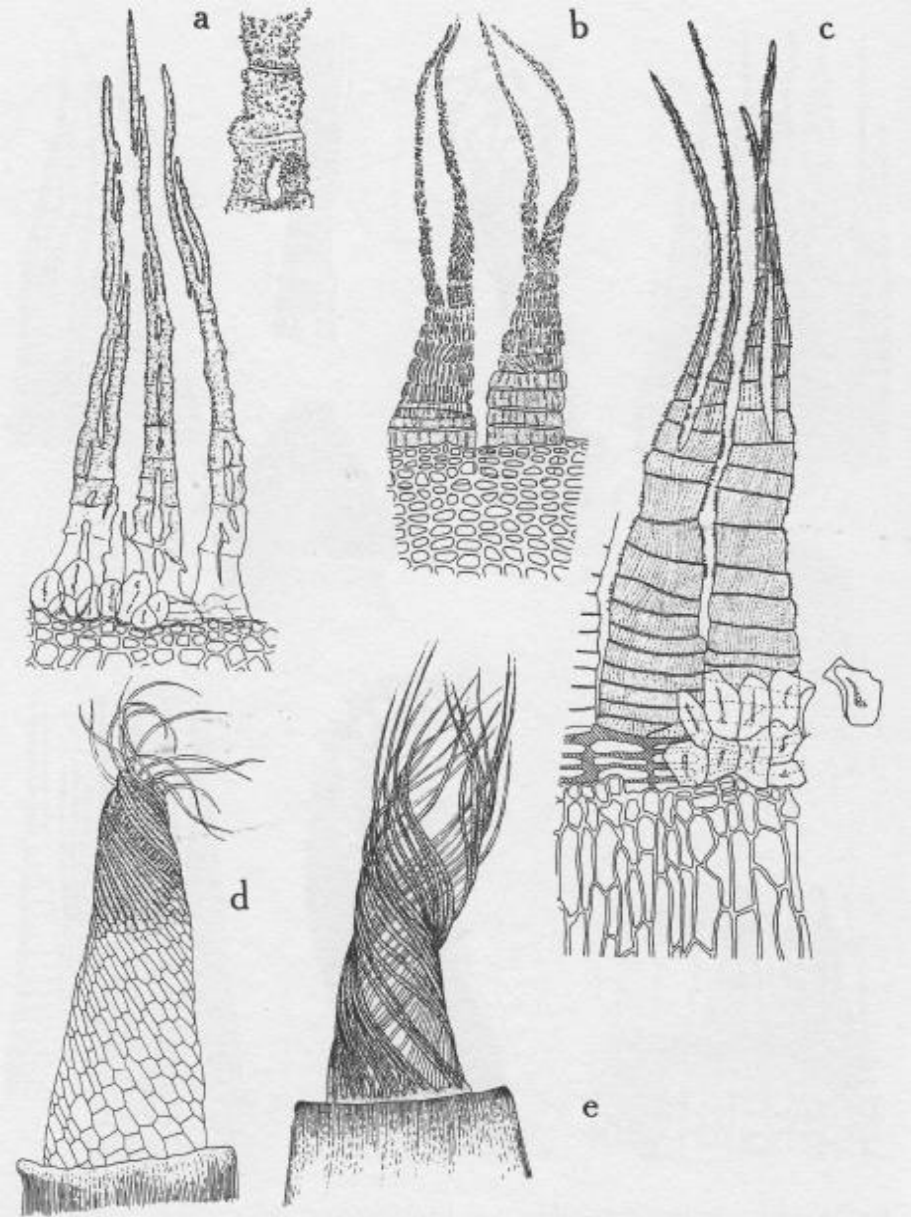

Tekeningen van Howard Crum: haploide (links) en diploide peristomen (rechts)

Challenge the future

Botanische Tuin TU Delft,
 Afdeling Biotechnologie, Faculteit Technische Natuurwetenschappen



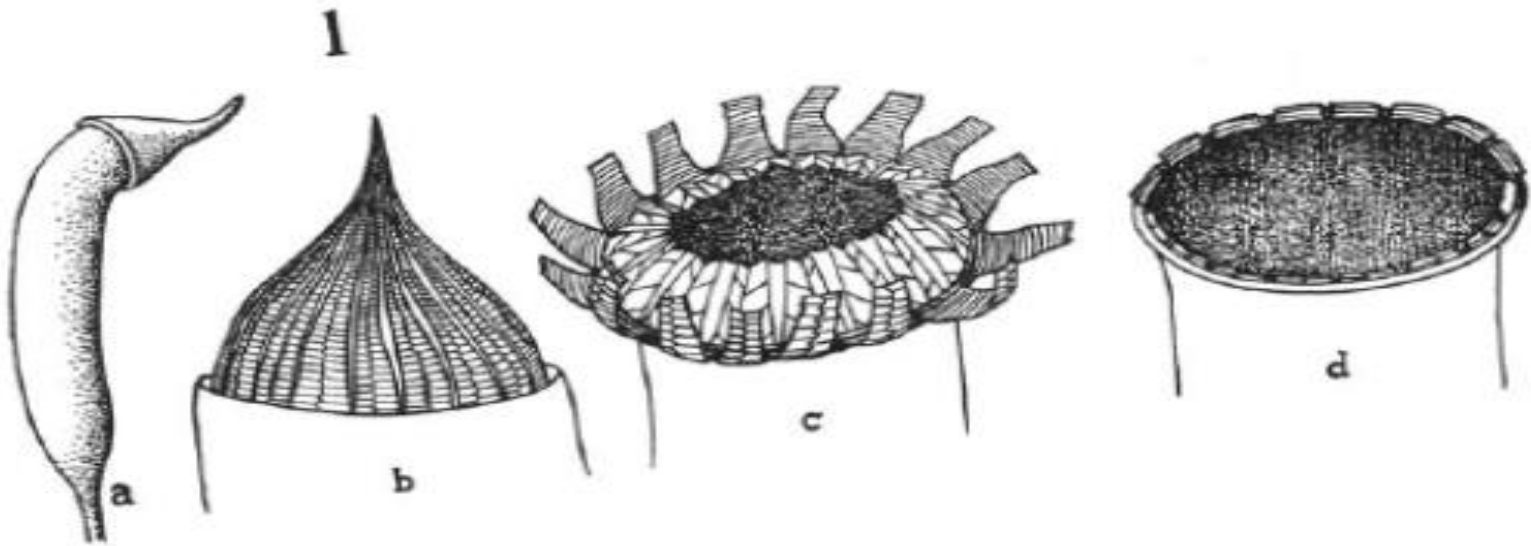

Mos peristomenen bewegen nog steeds na 200 jaar

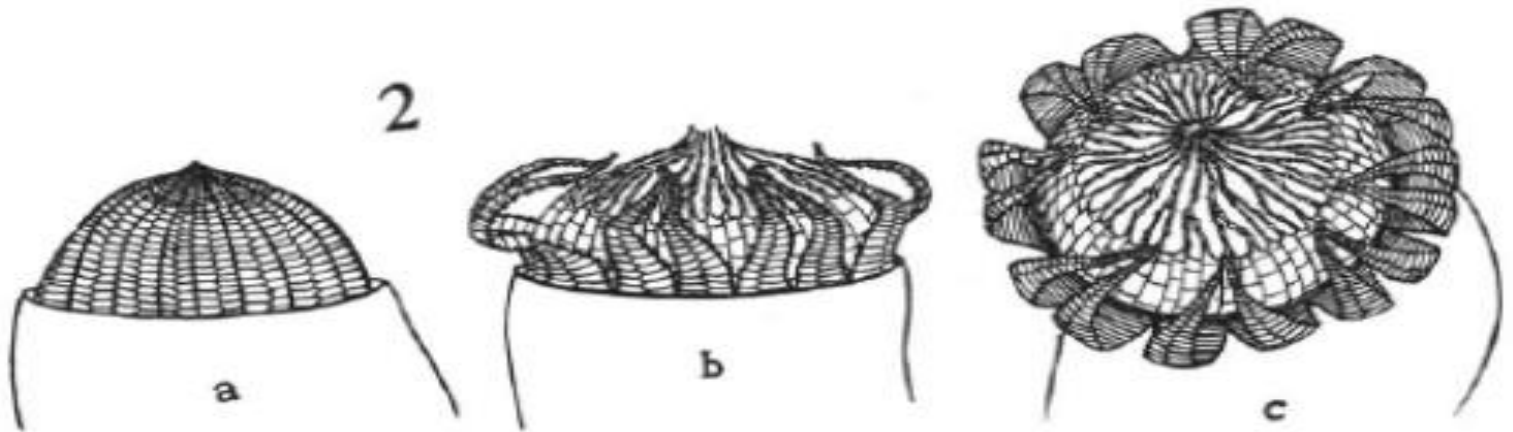

Challenge the future

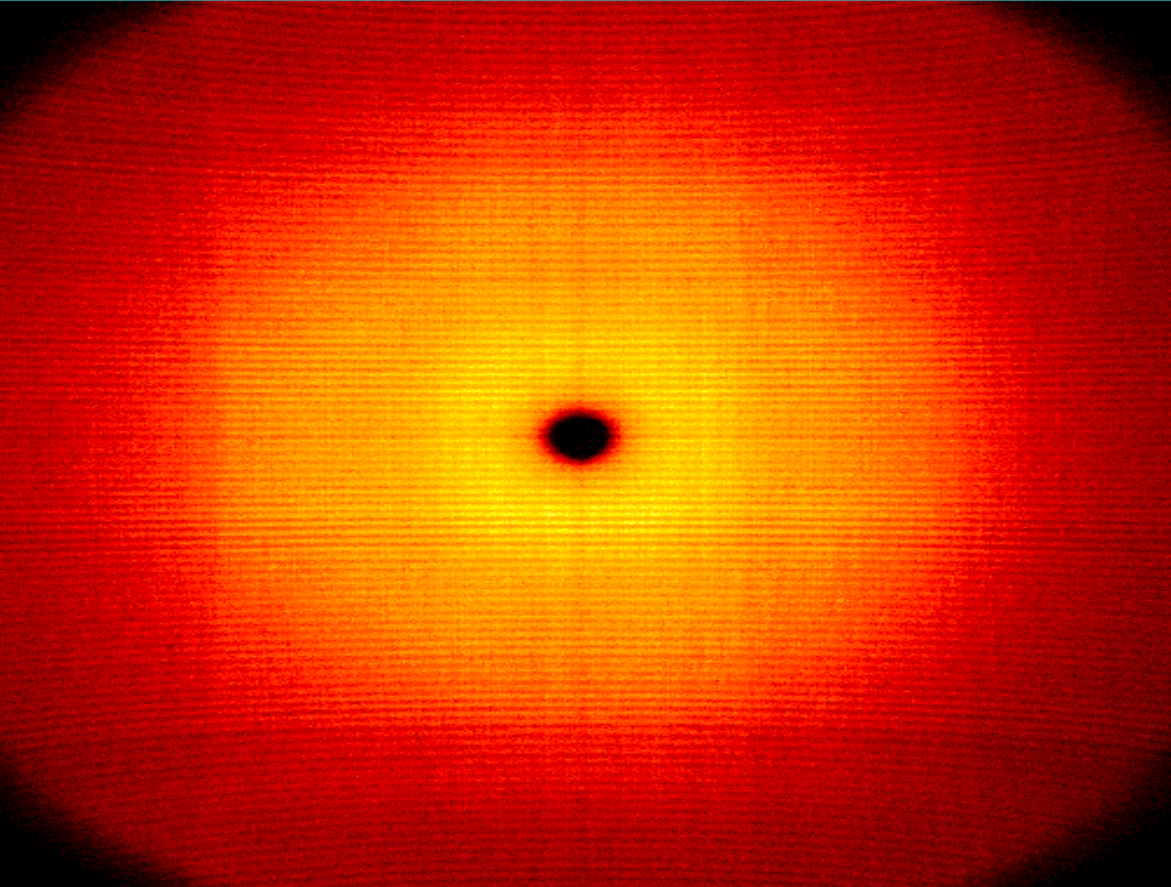

```

110309_00_0003.gfrm
03/21/11 10:58:02
Created 03/09/11
Mag,Quad 0 0
2-Theta 0.0000
Width 0.0000
Counts 54432995
Time (s) 3600.0
Distance 6.000
Size 1024

```

```

Frame was taken at
2-Theta 0.0000
Omega 0.0000
Phi 90.000
Chi 0.0000
X -4.898
Y -13.058
Z 0.366
Aux 1.490

```

```

2Th 0.000 X -12.176
Ome 0.000 Y -5.314
Phi 90.000 Z -1.058
Chi 0.000 Aux 1.490
Shutter CLOSED
Distance 6.000
FloodFld 1024_006 KV 20
Spatial 1024_006 MA 5
1024x1024 HV off

```



X Ray Diffractie van silicium of kiezel kristal zonder wateropname. Duidelijk zijn twee ringen te zien die kenmerkend zijn voor kiezel kristallen, een ring dichtbij en een ring op een grotere afstand van het centrum.

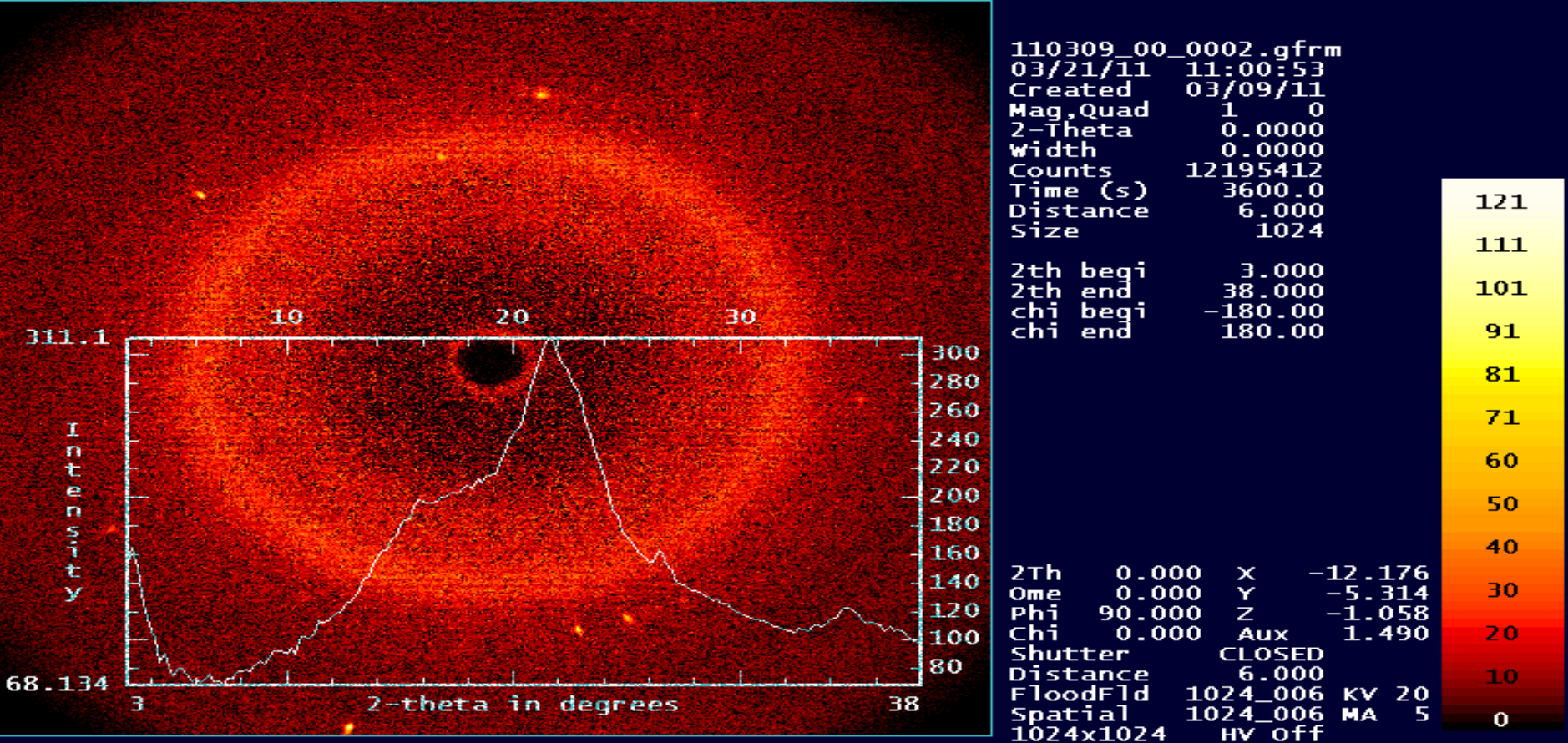

Dezelfde X Ray Diffractie van kiezel kristal na wateropname geeft een verschuiving vanaf het centrum van 3000 naar 38.000 angstrom veroorzaakt door intra kristallijne zwelling.
 Formule van Bragg: $2d \sin \Theta = n \lambda$ (d = afstand van diffractie in het kristal; Θ = de hoek van electronen bombardement (Theta); n = geheel getal; λ = golflengte (angstrom).
 De verschuiving door intra kristallijne zwelling: $d = 501.432$ angstrom of 501.432×10^{-10} meter.

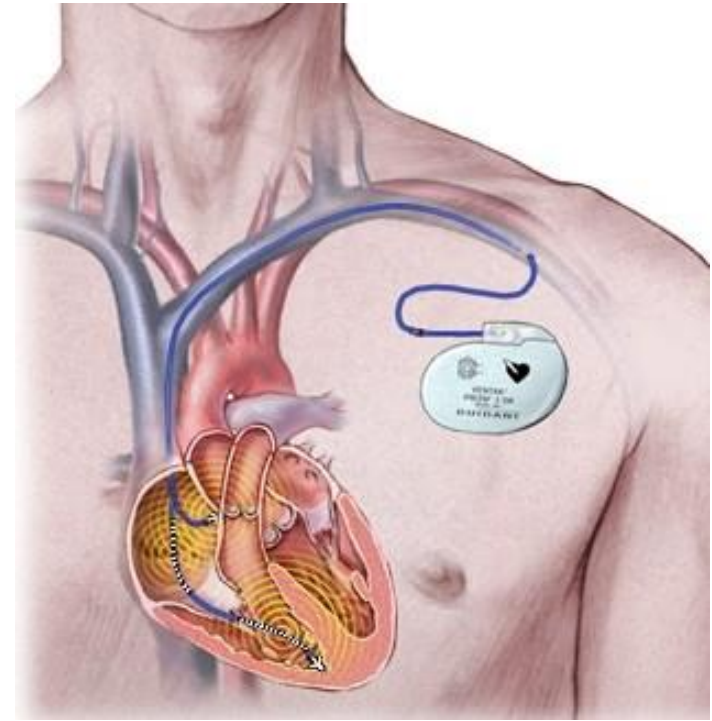
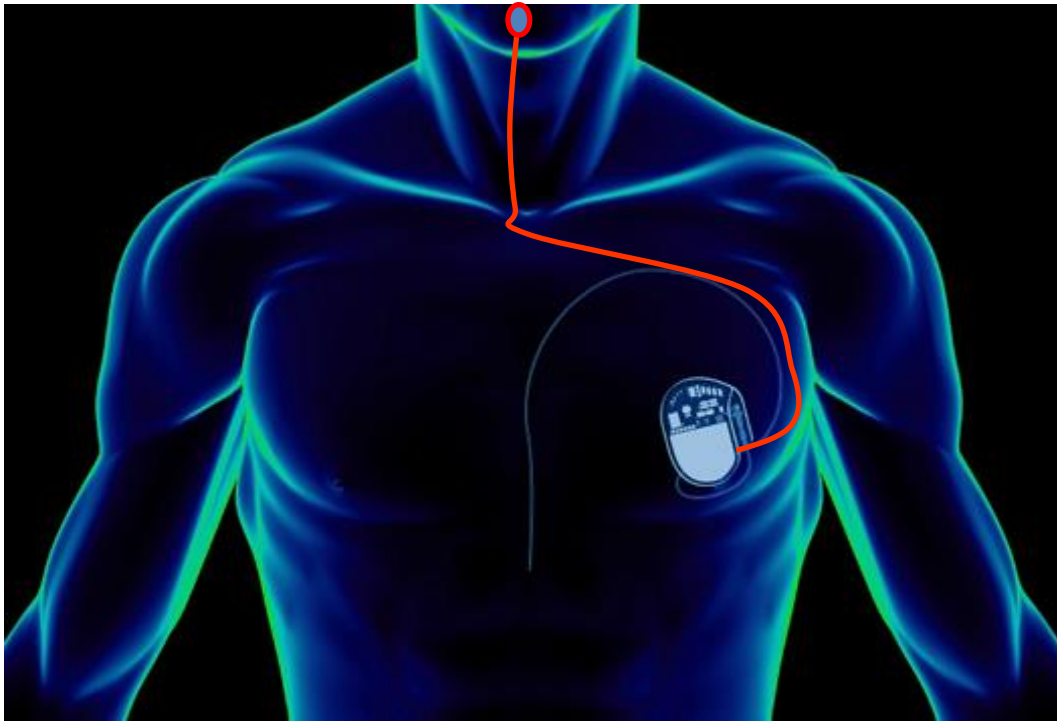

Vlak voordat een hartinfarct ontstaat neemt de luchtvochtigheid van de uitademing toe en een sensor in de mondholte kan dat verschil registreren.

Met de hygroscopische gestuurde beweging kunnen we een pre-diagnostisch alarmeringsysteem ontwikkelen om hart infarcten op te vangen door direct veranderende aansturing van de pacemaker (defibrillator).

Ook kunnen voor potentiële risico groepen direct automatisch een alarmnummer gebeld worden.

Challenge the future



Energie van zeewier: derde generatie biobrandstoffen

Solar Power from Sea

Large algae fields on open sea

Koolstofdioxide neutraal

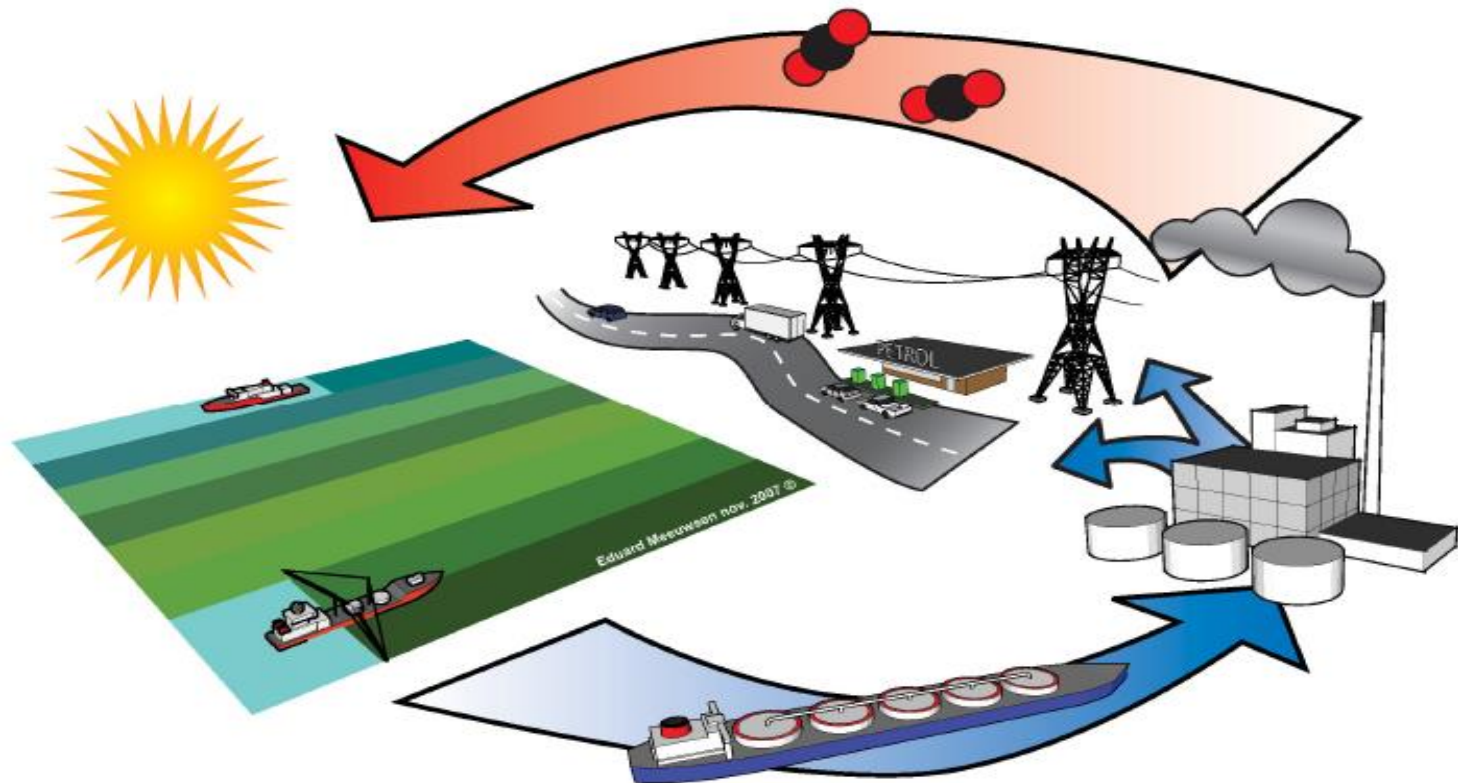

World Primary Energy Demand

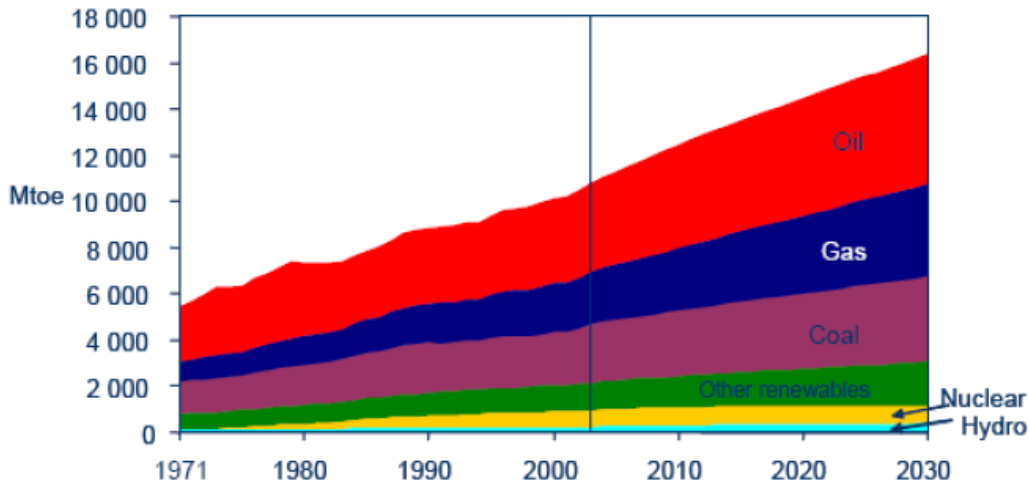

Productivity of bio-fuels

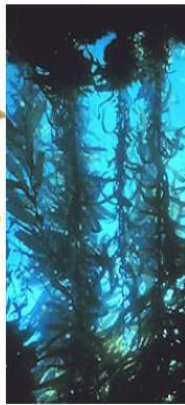
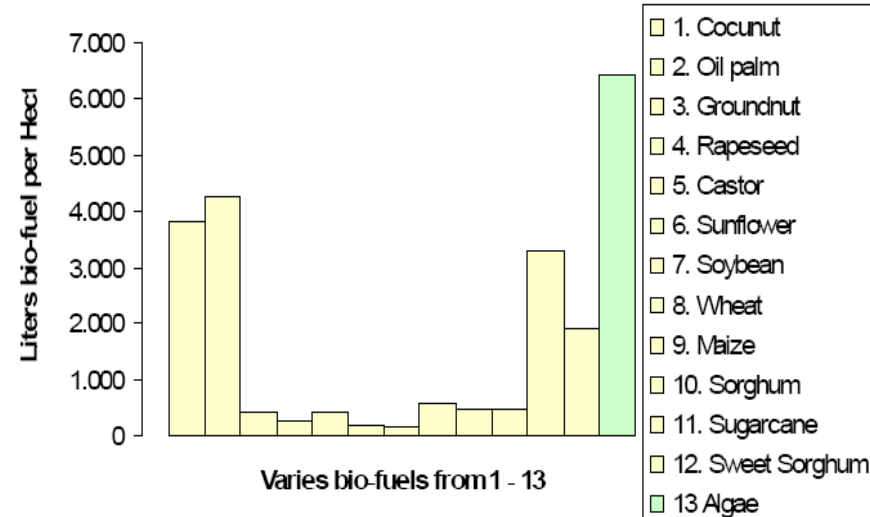

**Derde generatie
biobrandstoffen uit op zeeën en
oceanen**

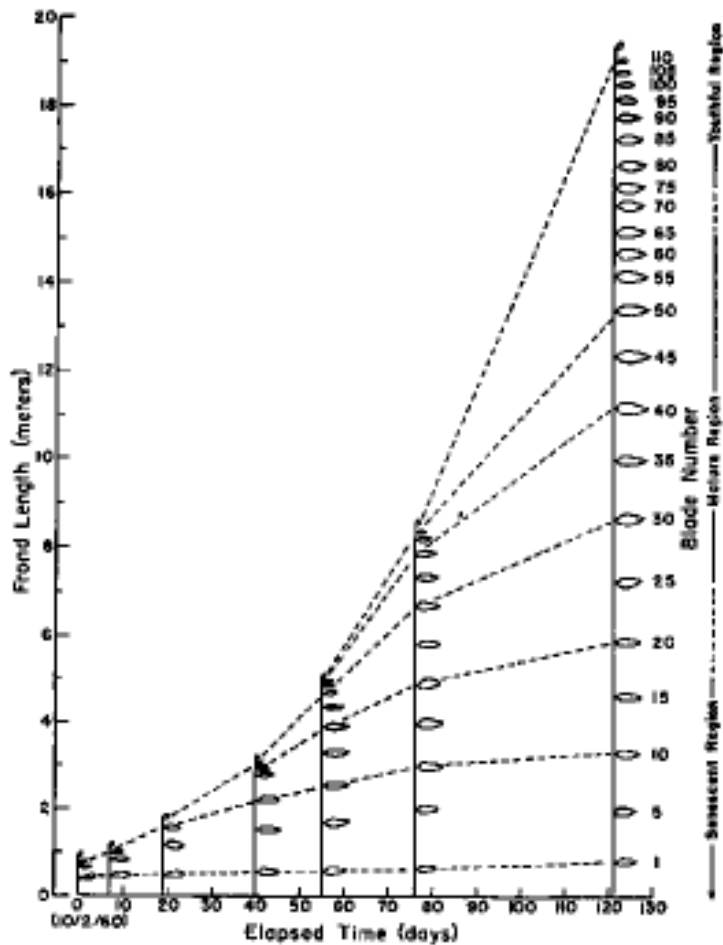

De groeicurve van volgroeide *Macrocyctis* zeewieren op een diepte van 20 meter in La Jolla Californië. De foto: volgroeide volwassen en jonge bladgroei ontwikkeling, zoals aangegeven in het groeischema (North, 1979)

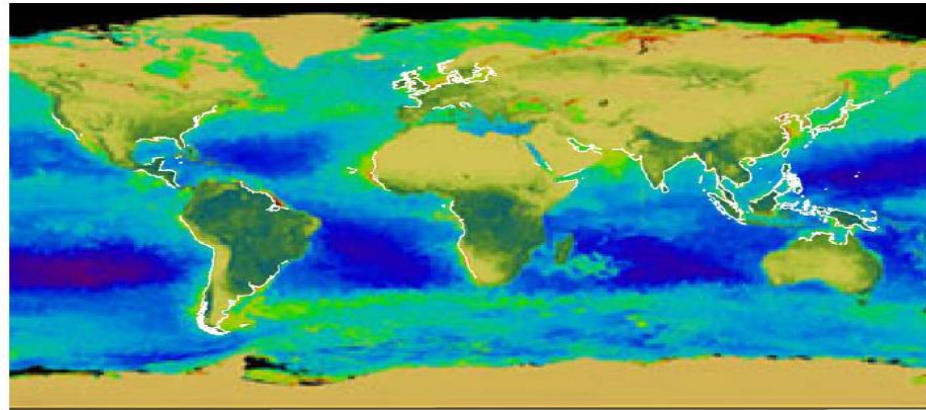

NCEP/NCAR
Reanalysis

Storm Tracks
Dec 1, 1997 - Feb 28, 1998

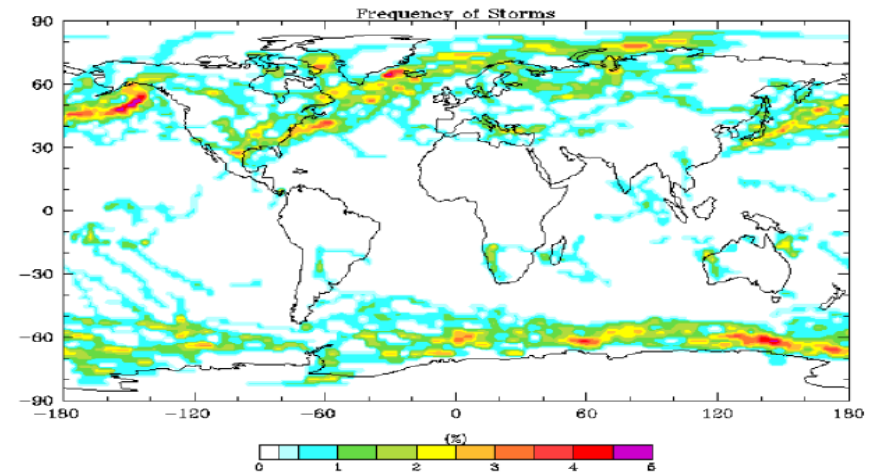

A PRESSURE LOW IS MINIMAL WITHIN A RADIUS OF 1440 KM,
AT MOST 1040 MB, LOCATED BETWEEN +04 AND -04 DEGREES LATITUDE.
SEA LEVEL PRESSURES ARE SAMPLED EVERY 6 HOURS.

STORMS ARE ASSUMED TO MOVE AT < 100 KM/HR
LAST FOR AT LEAST 36 HRS (6 SEGMENTS)
MOVING BY AT MOST 60 DEGREES

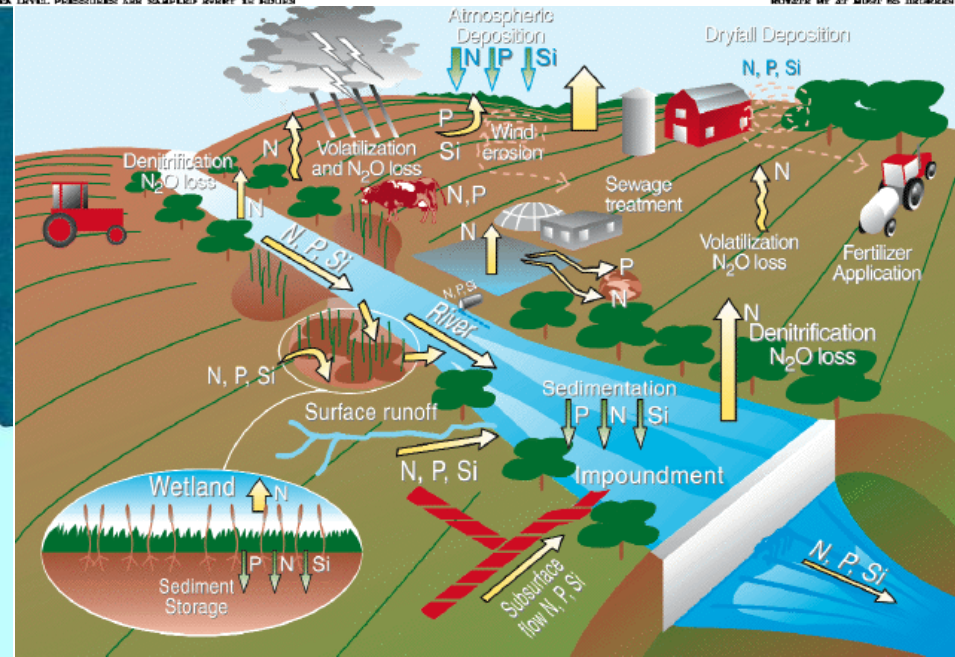
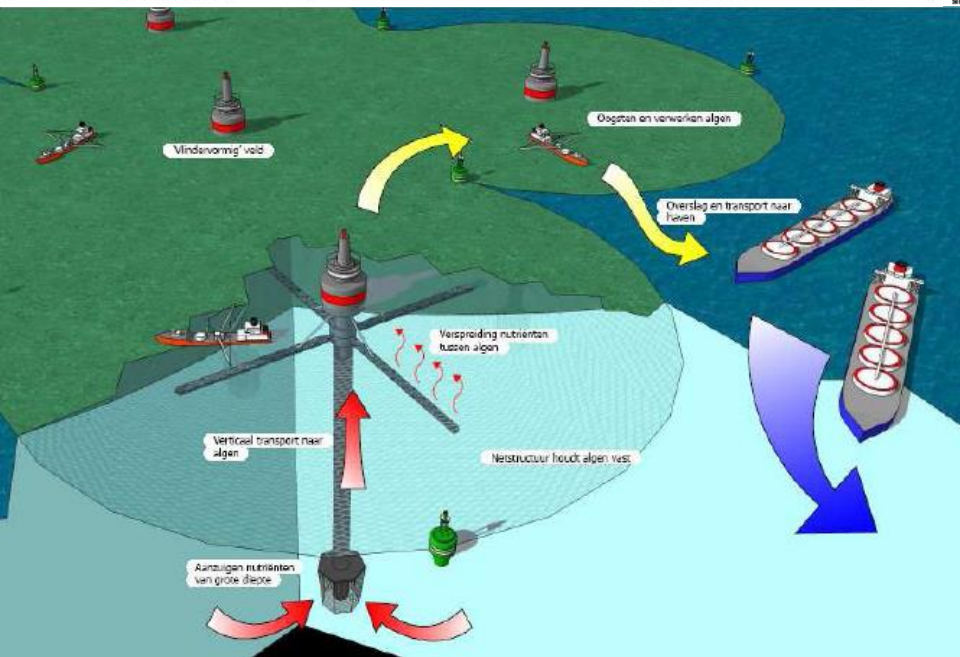

NIEUWE ONTWIKKELINGEN

Met Fibonacci patronen dubbel
groeisystemen creëren of een
fluorescente mutatie van een
konijn

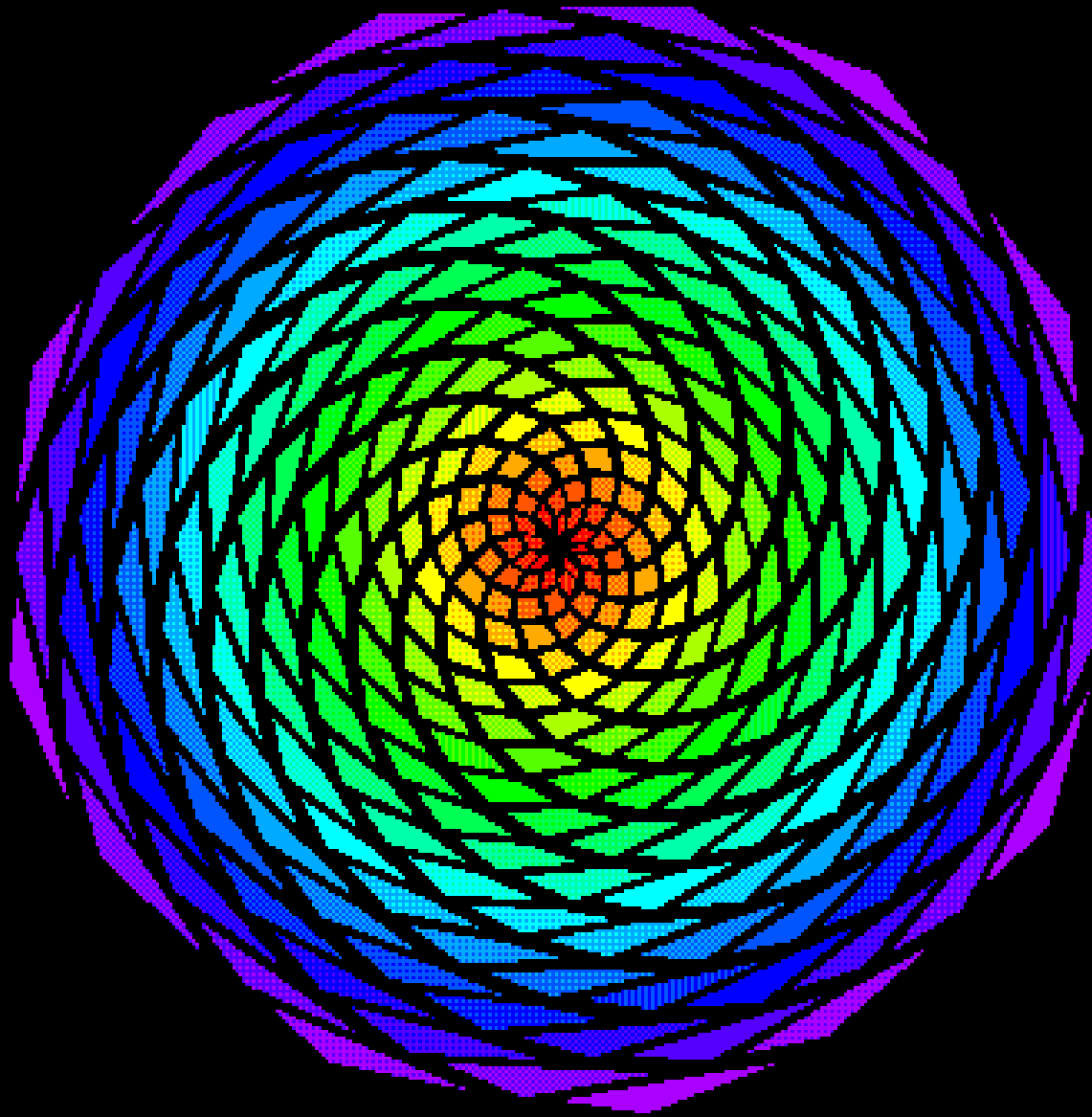

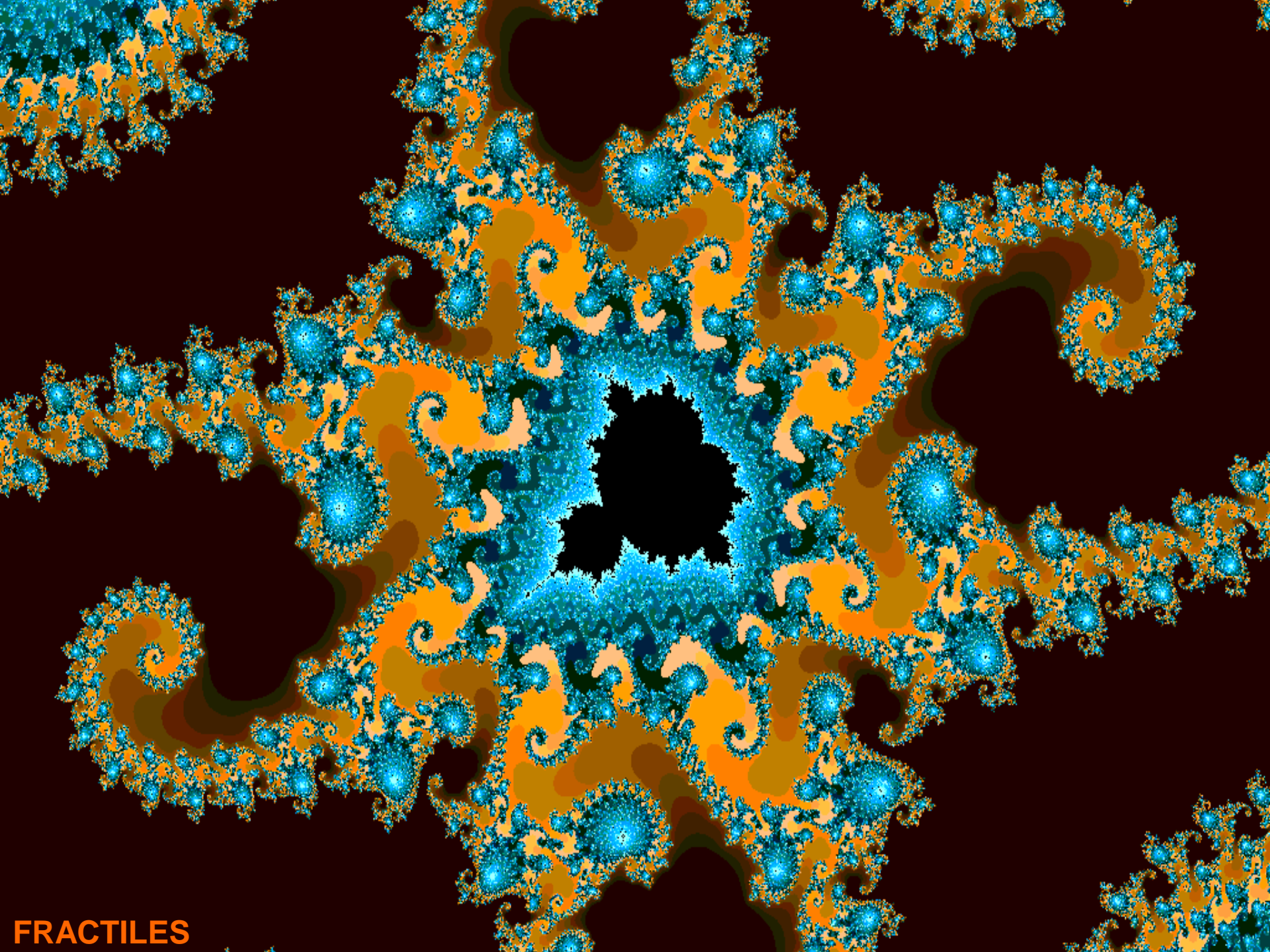

FRACTILES

De natuur als lerares in de toekomst: een voorbeeld voor space engineering/de ruimtevaart



Challenge the future

Botanische Tuin TU Delft, Afdeling Biotechnologie,
Faculteit Technische Natuurwetenschappen

 TU Delft

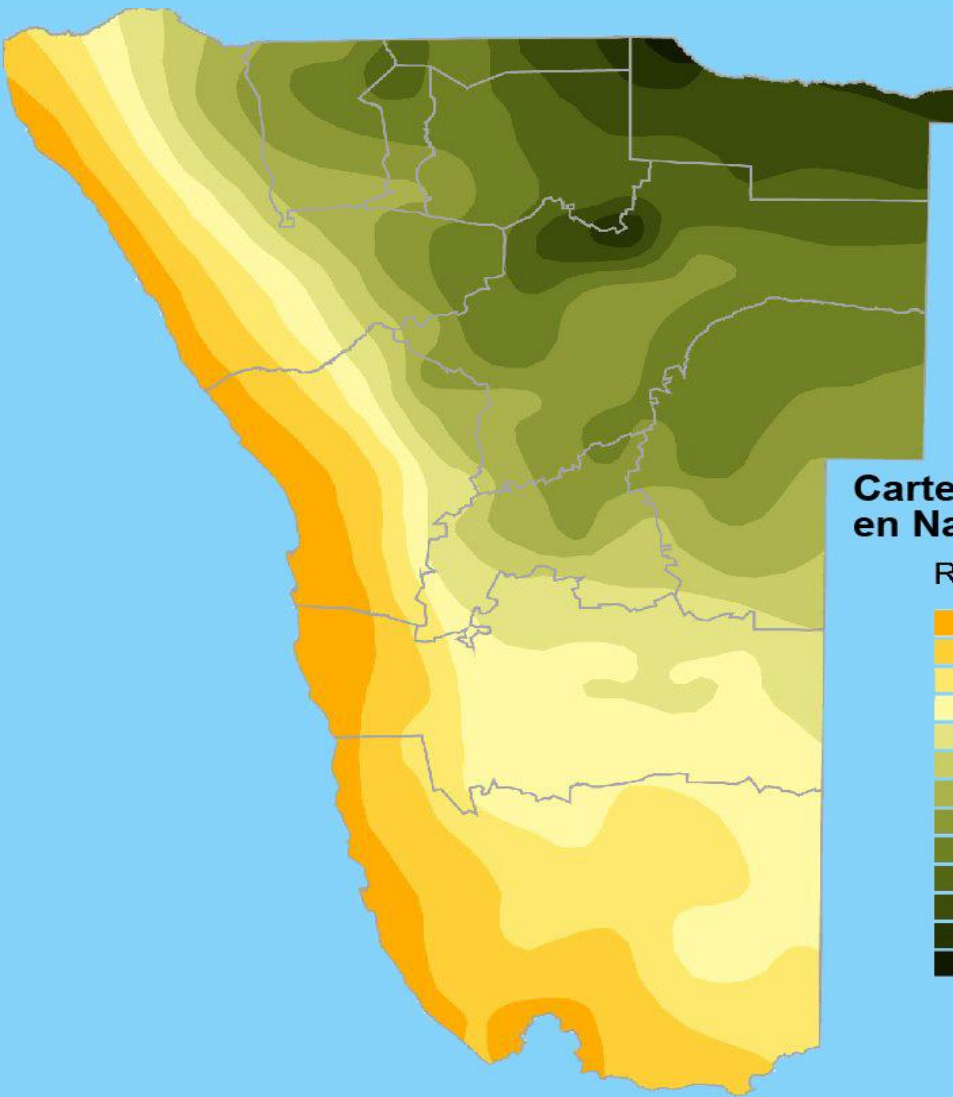

Carte des précipitation en Namibie

Rainfall (mm)

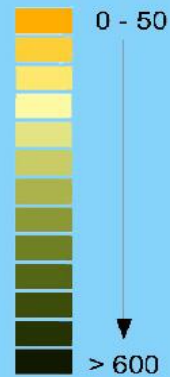

Exormotheca holstii groeit solitair in de Namib woestijn en heeft eens in de 5-7 jaar water nodig in de vorm van mist of regen.

Dit levermos kan overleven in deze condities en biedt ons kennis om onder extreme omstandigheden te groeien en reproduceren >> Space Engineering + zuurstof/genen

Challenge the future



Photo: K. Ammann

Exormotheca holstii, een extreem levermos van de Namib woestijn

Challenge the future

Botanische Tuin TU Delft, Afdeling Biotechnologie,
Faculteit Technische Natuurwetenschappen





Photo: K. Ammann



DANK VOOR UW AANDACHT